



ÜRÜN KATALOĐU

PRODUCT CATALOG

Hoş geldiniz! Welcome!

MEDICENZ PHARMA

Firmamız, tüm faaliyetlerinde yüksek kalite ve hizmet standartlarını korumayı taahhüt eder. Müşterilerimize her zaman üstün ürün ve hizmet sunmayı hedeflerken, çevresel sürdürülebilirliği, çalışan refahını ve sosyal sorumluluğu gözetiriz. Bu ilkeler doğrultusunda, müşterilerimize sürekli değer sunmaya devam edeceğiz.

Our company is committed to maintaining the highest standards of quality and service in all our operations. We aim to consistently provide our customers with superior products and services while prioritizing environmental sustainability, employee well-being, and social responsibility. In line with these principles, we will continue to deliver value to our customers.



Kalite Güvencesi

Quality Assurance

Ürün Kalitesi: Ürünlerimizin mükemmelliğini sağlamak için sıkı kalite kontrol önlemlerine uyuyoruz. Her ürün, endüstri standartlarına ve müşteri beklentilerine uygunluğunu sağlamak amacıyla titiz test ve denetimlere tabi tutulmaktadır.

Süreç İyileştirmesi: Üretim süreçlerimizi sürekli olarak gözden geçirip iyileştirerek verimliliği ve ürün kalitesini artırıyoruz. Sürekli analiz ve yenilik yoluyla, endüstri standartlarını aşmayı ve üstün sonuçlar elde etmeyi hedefliyoruz.

Product Quality: We adhere to strict quality control measures to ensure the excellence of our products. Each product undergoes rigorous testing and inspection to ensure compliance with industry standards and customer expectations.

Process Improvement: We continuously review and improve our production processes to enhance efficiency and product quality. Through ongoing analysis and innovation, we aim to exceed industry standards and achieve outstanding results.

Müşteri Memnuniyeti

Customer Satisfaction

Müşteri Odaklı Yaklaşım: Müşterilerimiz her şeyin merkezindedir. Müşteri ihtiyaçlarını ve geri bildirimlerini önceliklendirir, her fırsatta beklentilerini aşmayı hedefleriz.

Hızlı Yanıt: Müşteri soruları, endişeleri ve geri bildirimlerine zamanında ve etkili yanıtlar sağlamayı taahhüt ediyoruz. Açık iletişim kanalları, müşteri ihtiyaçlarının hızlı ve tatmin edici bir şekilde ele alınmasını sağlar.

Customer-Centric Approach: Our customers are at the heart of everything we do. We prioritize their needs and feedback, aiming to exceed their expectations at every opportunity.

Prompt Response: We are committed to providing timely and effective responses to customer inquiries, concerns, and feedback. Open communication channels ensure that customer needs are addressed quickly and satisfactorily.

Hakkımızda About Us

Medicenz Pharma Ecza Deposu, 2018 yılında Türkiye Sağlık Bakanlığı'ndan faaliyet izni olarak Ankara'da kurulmuştur. Medicenz Pharma Ecza Deposu aynı zamanda Depo Dağıtım Lisansı'na (WDL) sahiptir. Kurucularımızın sektördeki 30 yılı aşkın tecrübesi ile Medicenz Pharma Ecza Deposu, alanında yenilikçi çözümler sunarak en iyi hizmeti vermeye çalışmaktadır.

Medicenz Pharma Pharmaceutical Warehouse was established in Ankara in 2018 after obtaining the necessary license from the Turkish Ministry of Health to operate. Medicenz Pharma Pharmaceutical Warehouse also holds a Warehouse Distribution License (WDL). With over 30 years of experience in the industry, our founders strive to provide the best service by offering innovative solutions in the field.

✓ **30 yılı aşkın bir deneyim ve bunun getirdiği iş etiği anlayışıyla, müşterilerine hizmet vermektedir.**

With over 30 years of experience and the work ethic it brings, it provides service to its customers.

✓ **Sektörde tecrübeli ekibimiz, müşterilerinin istekleri doğrultusunda en kaliteli ürünleri en uygun fiyatlarla dünyanın her yerine ulaştırmaktadır.**

Our experienced team in the industry delivers the highest quality products at the most competitive prices to customers around the world, based on their requests.

✓ **Uzman ve dinamik ekibiyle, yurtiçi ve yurtdışında aktif faaliyet göstermekle birlikte, müşteri memnuniyetini esas alan bir kadroya sahiptir.**

With its expert and dynamic team, it operates actively both domestically and internationally, with a staff focused on customer satisfaction.

İÇİNDEKİLER / CONTENTS

Genel Cerrahi Örtü Setleri / General Surgical Drape Sets	6
Genel Cerrahi Örtü Seti 1 / General Surgical Drape Set 1	7
Genel Cerrahi Örtü Seti 2 / General Surgical Drape Set 2	8
Genel Cerrahi Örtü Seti 3 / General Surgical Drape Set 3	9
Abdominal Örtü Seti / Abdominal Drape Set	10
Laparoskopi Örtü Seti / Laparoscopy Drape Set	11
Laparotomi Örtü Seti / Laparotomy Drape Set	12
Minör Cerrahi Örtü Seti / Minor Surgical Drape Set	13
Pansuman Örtü Seti / Dressing Drape Set	14
Sünnet Örtü Seti / Circumcision Drape Set	15
Ortopedi Örtü Setleri / Orthopedic Drape Sets	16
Artroskopi Örtü Seti / Arthroscopy Drape Set	17
Ekstremitte Örtü Seti / Extremity Drape Set	18
El Cerrahi Örtü Seti / Hand Surgical Drape Set	19
Diz Örtü Seti / Knee Drape Set	20
Omuz Örtü Seti / Shoulder Surgical Drape Set	21
Artroplasti (Kalça) Örtü Seti / Arthroplasty (Hip) Drape Set	22
Vertebra Örtü Seti / Vertebra Surgical Drape Set	23
Kardiyoloji Örtü Setleri / Cardiology Drape Sets	24
Anjiyografi Örtü Seti / Angiography Drape Set	25
Anjiyografi Panelli Örtü Seti / Angiography Drape With Panel Set	26
BY-PASS Örtü Seti / BY-PASS Drape Set	27
Kalp Kapakçığı Örtü Seti / Cardiac Valve Drape Set	28
Kardiyovasküler Örtü Seti / Cardiovascular Drape Set	29
Jinekoloji Örtü Setleri / Gynecology Drape Sets	30
Embriyo Transfer Örtü Seti / Embryo Transfer Drape Set	31
I.V.F. (Tüp Bebek) Örtü Seti / I.V.F. Drape Set	32
Doğum Örtü Seti / Maternity Drape Set	33
Sezeryan Örtü Seti 1 / Cesarean Drape Set 1	34
Sezeryan Örtü Seti 2 / Cesarean Drape Set 2	35
O.P.U Örtü Seti / O.P.U. Drape Set	36

İÇİNDEKİLER / CONTENTS

Litotomi Örtü Seti / Lithotomy Drape Set	37
Beyin Cerrahi Örtü Setleri / Neurosurgery Drape Sets	38
Kraniyotomi Örtü Seti / Craniotomy Drape Set	39
Shunt Örtü Seti / Shunt Drape Set	40
Spinal Örtü Seti / Spinal Drape Set	41
Oftalmoloji Örtü Setleri / Ophthalmology Drape Sets	42
Göz Örtü Seti / Eye Drape Set	43
Çift Poşlu Göz Örtüleri / Eye Drapes With Double Pouch	44
Tek Poşlu Göz Örtüleri / Eye Drapes With Pouch	45
Onkoloji Örtü Setleri / Oncology Drape Sets	46
Kemoterapi Örtü Seti / Chemotherapy Drape Set	47
Üroloji Örtü Setleri / Urology Drape Sets	48
Perkütan Örtü Seti / Percutaneous Drape Set	49
T.U.R. Örtü Seti / T.U.R. Drape Set	50
Sistoskopi Örtü Seti / Cystoscopy Drape Set	51
Radyoloji Örtü Setleri / Radiology Drape Sets	52
Biopsi (Tese) Örtü Seti / Biopsy (Tese) Drape Set	53
K.B.B. Cerrahi Örtü Setleri / E.N.T. Drape Sets	54
K.B.B. Örtü Seti / E.N.T. Drape Set	55
Tiroid Örtü Seti / Thyroid Drape Set	56
Estetik Cerrahi Örtü Setleri / Aesthetic Drape Sets	57
Rinoplasti Örtü Seti / Rhinoplasty Drape Set	58
Liposculptre Örtü Seti / Liposculptre Drape Set	59
Saç Ekim Örtü Seti / Hair Transplantation Drape Set	60
Diş Cerrahi Örtü Setleri / Dental Drape Sets	61
Diş Örtü Seti / Dental Drape Set	62
Implant Örtü Seti / Implant Drape Set	63
Cerrahi Önlükler / Surgical Gowns	64
Önlük Setleri / Gown Sets	64-65
Diğer Tek Kullanımlık Ürünler / Other Disposable Products	66
Maske / Mask	67



Genel Cerrahi Örtü Setleri General Surgical Drape Sets

10 x 50 cm
OP-TAPE
OP-TAPE

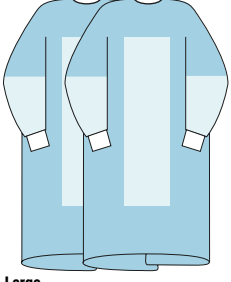

Large
TAKVİYELİ CERRAHİ ÖNLÜK
REINFORCED SURGICAL GOWN

40 x 40 cm
HAVLU
TOWEL

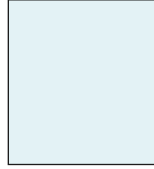

100 x 100 cm
STERİLİZASYON BOHÇASI
STERILIZATION WRAP



78 x 145 cm
MAYO MASA ÖRTÜSÜ
MAYO TABLE DRAPE

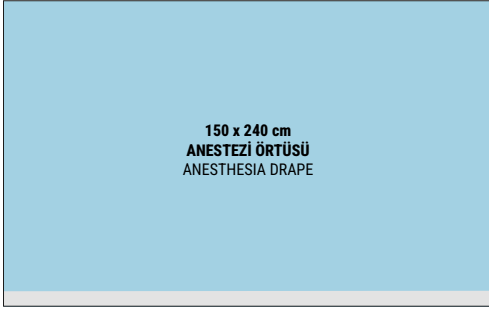

150 x 240 cm
ANESTEZİ ÖRTÜSÜ
ANESTHESIA DRAPE

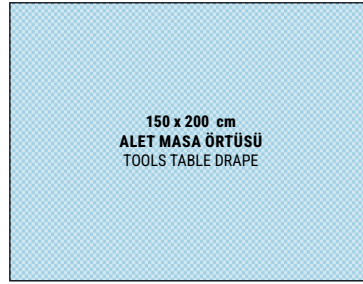

150 x 200 cm
ALET MASA ÖRTÜSÜ
TOOLS TABLE DRAPE



150 x 180 cm
AYAK ÖRTÜSÜ
LEG DRAPE



75 x 90 cm
YAPIŞKAN BANTLI ÖRTÜ
DRAPE WITH ADHESIVE TAPE

REF: MED-STR001

Genel Cerrahi Örtü Seti 1

General Surgical Drape Set 1

İÇERİK / CONTENT

EBAT / SIZE

ADET / PIECES

Anestezi Örtüsü
Anesthesia Drape

150 x 240 cm

1

Ayak Örtüsü
Leg Drape

150 x 180 cm

1

Yapışkan Bantlı Örtü
Drape With Adhesive Tape

75 x 90 cm

2

Alet Masa Örtüsü
Tools Table Drape

150 x 200 cm

1

Mayo Masa Örtüsü
Mayo Table Drape

78 x 145 cm

1

Op-Tape
Op-Tape

10 x 50 cm

2

Takviyeli Cerrahi Önlük
Reinforced Surgical Gown

Large

2

Havlu
Towel

40x 40 cm

2

Sterilizasyon Bohçası
Sterilization Wrap

100 x 100 cm

1



10 x 50 cm
OP-TAPE
OP-TAPE

40 x 40 cm
HAVLU
TOWEL

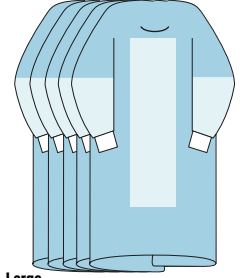

Large
TAKVİYELİ CERRAHİ ÖNLÜK
REINFORCED SURGICAL GOWN

100 x 100 cm
STERİLİZASYON BOHÇASI
STERILIZATION WRAP

78 x 145 cm
MAYO MASA ÖRTÜSÜ
MAYO TABLE DRAPE

75 x 90 cm
YAPIŞKAN BANTLI ÖRTÜ
DRAPE WITH ADHESIVE TAPE

150 x 200 cm
ALET MASA ÖRTÜSÜ
TOOLS TABLE DRAPE

150 x 240 cm
ANESTEZİ ÖRTÜSÜ
ANESTHESIA DRAPE

REF: MED-STRO02

Genel Cerrahi Örtü Seti 2

General Surgical Drape Set 2

İÇERİK / CONTENT

EBAT / SIZE

ADET / PIECES

Anestezi Örtüsü
Anesthesia Drape

150 x 240 cm

2

Yapışkan Bantlı Örtü
Drape With Adhesive Tape

75 x 90 cm

2

Alet Masa Örtüsü
Tools Table Drape

150 x 200 cm

1

Mayo Masa Örtüsü
Mayo Table Drape

78 x 145 cm

1

Op-Tape
Op-Tape

10 x 50 cm

2

Takviyeli Cerrahi Önlük
Reinforced Surgical Gown

Large

5

Havlu
Towel

40x 40 cm

5

Sterilizasyon Bohçası
Sterilization Wrap

100 x 100 cm

1

10 x 50 cm
OP-TAPE
OP-TAPE

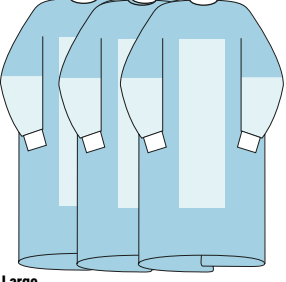

Large
TAKVİYELİ CERRAHİ ÖNLÜK
REINFORCED SURGICAL GOWN

40 x 40 cm
HAVLU
TOWEL



78 x 145 cm
MAYO MASA ÖRTÜSÜ
MAYO TABLE DRAPE

30 x 30 cm
ŞEFFAF BANTLI KESE
TRANSPARENT TAPE POUCH

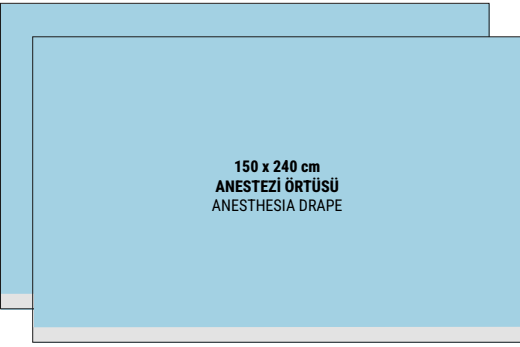

150 x 240 cm
ANESTEZİ ÖRTÜSÜ
ANESTHESIA DRAPE

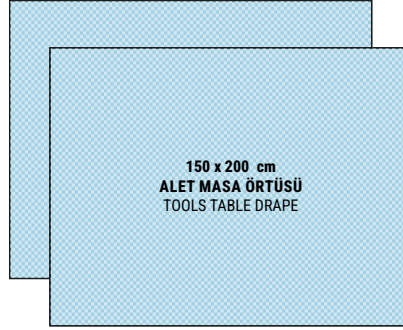

150 x 200 cm
ALET MASA ÖRTÜSÜ
TOOLS TABLE DRAPE

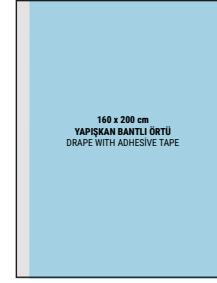

160 x 200 cm
YAPIŞKAN BANTLI ÖRTÜ
DRAPE WITH ADHESIVE TAPE



100 x 120 cm
YAPIŞKAN BANTLI ÖRTÜ
DRAPE WITH ADHESIVE TAPE

REF: MED-STRO03

Genel Cerrahi Örtü Seti 3

General Surgical Drape Set 3

İÇERİK / CONTENT	EBAT / SIZE	ADET / PIECES
Anestezi Örtüsü Anesthesia Drape	150 x 240 cm	2
Yapışkan Bantlı Örtü Drape With Adhesive Tape	160 x 200 cm	1
Yapışkan Bantlı Örtü Drape With Adhesive Tape	100 x 120 cm	2
Alet Masa Örtüsü Tools Table Drape	150 x 200 cm	2
Mayo Masa Örtüsü Mayo Table Drape	78 x 145 cm	1
Op-Tape Op-Tape	10 x 50 cm	2
Takviyeli Cerrahi Önlük Reinforced Surgical Gown	X Large	3
Havlu Towel	40x 40 cm	2
Şeffaf Bantlı Kесе Transparent Tape Pouch	30 x 30 cm	1

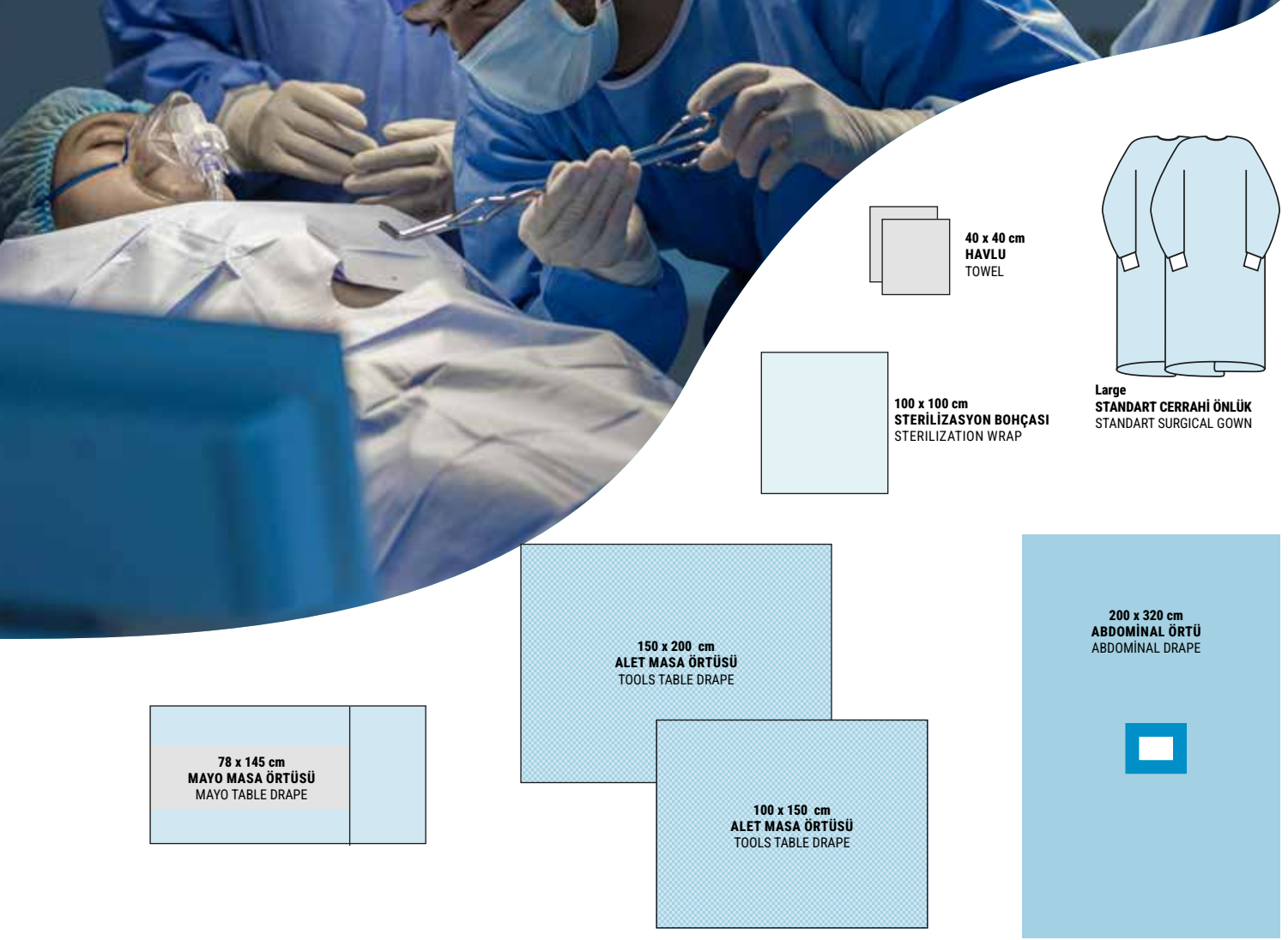

40 x 40 cm
HAVLU
TOWEL

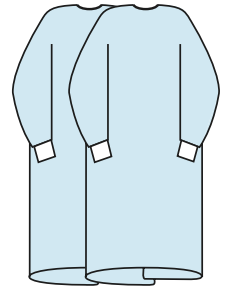

Large
STANDART CERRAHİ ÖNLÜK
STANDART SURGICAL GOWN

100 x 100 cm
STERİLİZASYON BOHÇASI
STERILIZATION WRAP

150 x 200 cm
ALET MASA ÖRTÜSÜ
TOOLS TABLE DRAPE

100 x 150 cm
ALET MASA ÖRTÜSÜ
TOOLS TABLE DRAPE

200 x 320 cm
ABDOMİNAL ÖRTÜ
ABDOMİNAL DRAPE

78 x 145 cm
MAYO MASA ÖRTÜSÜ
MAYO TABLE DRAPE

REF: MED-STRO04

Abdominal Örtü Seti

Abdominal Drape Set

İÇERİK / CONTENT

EBAT / SIZE

ADET / PIECES

Abdominal Örtü
Abdominal Drape

200 x 320 cm

1

Alet Masa Örtüsü
Tools Table Drape

100 x 150 cm

1

Alet Masa Örtüsü
Tools Table Drape

150 x 200 cm

1

Mayo Masa Örtüsü
Mayo Table Drape

78 x 145 cm

1

Standart Cerrahi Önlük
Standart Surgical Gown

Large

2

Havlu
Towel

40 x 40 cm

2

Sterilizasyon Bohçası
Sterilization Wrap

100 x 100 cm

1

10 x 50 cm
OP-TAPE
OP-TAPE

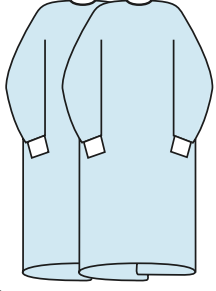

Large
STANDART CERRAHİ ÖNLÜK
STANDART SURGICAL GOWN

40 x 40 cm
HAVLU
TOWEL

78 x 145 cm
MAYO MASA ÖRTÜSÜ
MAYO TABLE DRAPE

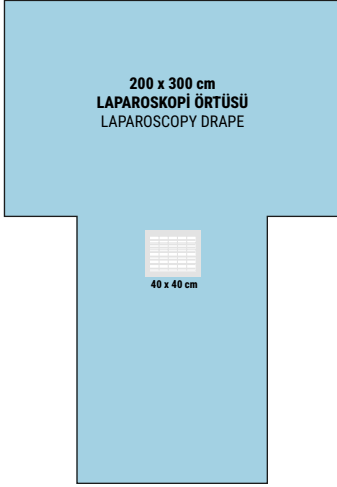

200 x 300 cm
LAPAROSKOPİ ÖRTÜSÜ
LAPAROSCOPY DRAPE

40 x 40 cm

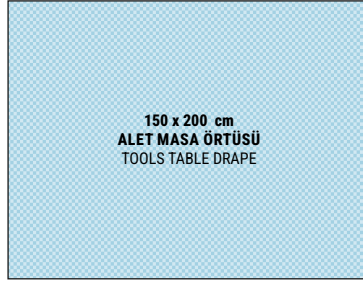

150 x 200 cm
ALET MASA ÖRTÜSÜ
TOOLS TABLE DRAPE

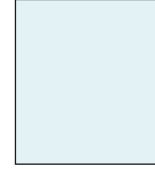

100 x 100 cm
STERİLİZASYON BOHÇASI
STERILIZATION WRAP

REF: MED-STRO05

Laparoskopi Örtü Seti

Laparoscopy Drape Set

İÇERİK / CONTENT

EBAT / SIZE

ADET / PIECES

Laparoskopi Örtüsü
Laparoscopy Drape

200 x 300 cm

1

Alet Masa Örtüsü
Tools Table Drape

100 x 150 cm

1

Mayo Masa Örtüsü
Mayo Table Drape

78 x 145 cm

1

Standart Cerrahi Önlük
Standart Surgical Gown

Large

2

Op-Tape
Op-Tape

10 x 50 cm

2

Havlu
Towel

40 x 40 cm

2

Sterilizasyon Bohçası
Sterilization Wrap

100 x 100 cm

1



10 x 30 cm
OP-TAPE
OP-TAPE

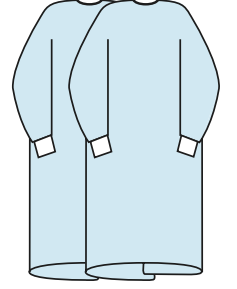

Large
STANDART CERRAHİ ÖNLÜK
STANDART SURGICAL GOWN

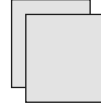

40 x 40 cm
HAVLU
TOWEL

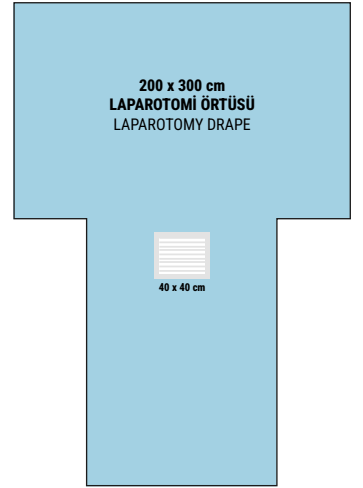

200 x 300 cm
LAPAROTOMİ ÖRTÜSÜ
LAPAROTOMY DRAPE

REF: MED-STRO06

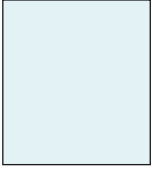

100 x 100 cm
STERİLİZASYON BOHÇASI
STERILIZATION WRAP

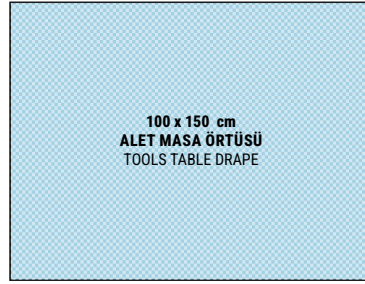

100 x 150 cm
ALET MASA ÖRTÜSÜ
TOOLS TABLE DRAPE

Laparotomi Örtü Seti

Laparotomy Drape Set

İÇERİK / CONTENT

EBAT / SIZE

ADET / PIECES

Laparotomi Örtüsü
Laparotomy Drape

200 x 300 cm

1

Alet Masa Örtüsü
Tools Table Drape

100 x 150 cm

1

Op-Tape
Op-Tape

10 x 30 cm

2

Standart Cerrahi Önlük
Standart Surgical Gown

Large

2

Havlu
Towel

40 x 40 cm

2

Sterilizasyon Bohçası
Sterilization Wrap

100 x 100 cm

1

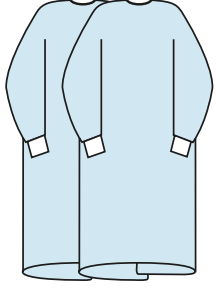

Large
STANDART CERRAHİ ÖNLÜK
STANDART SURGICAL GOWN

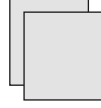

40 x 40 cm
HAVLU
TOWEL

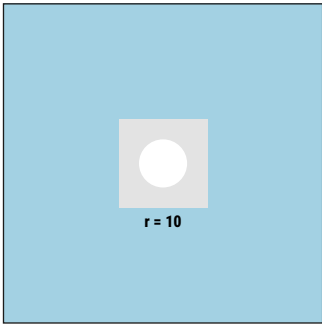

75 x 75 cm
MINÖR DELİKLİ ÖRTÜ
MINOR SURGICAL DRAPE

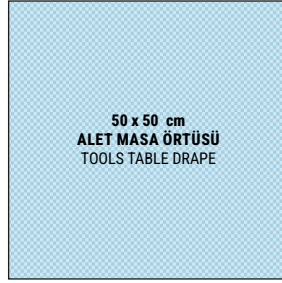

50 x 50 cm
ALET MASA ÖRTÜSÜ
TOOLS TABLE DRAPE



50 x 50 cm
STERİLİZASYON BOHÇASI
STERILIZATION WRAP

REF: MED-STRO07

Minör Cerrahi Örtü Seti

Minor Surgical Drape Set

İÇERİK / CONTENT

EBAT / SIZE

ADET / PIECES

Minör Delikli Örtü
Minor Surgical Drape

75 x 75 cm

1

Alet Masa Örtüsü
Tools Table Drape

50 x 50 cm

1

Standart Cerrahi Önlük
Standart Surgical Gown

Large

2

Havlu
Towel

40 x 40 cm

2

Sterilizasyon Bohçası
Sterilization Wrap

50 x 50 cm

1



5 7,5 x 7,5 cm
SPANÇ
GAUZE SWAB

60 x 60 cm
DELİKLİ YAPIŞKAN BANTLI ÖRTÜ
FENESTRATED DRAPE WITH ADHESIVE TAPE

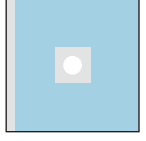

40 x 40 cm
HAVLU
TOWEL

250 cc
SOLÜSYON KABİ
SOLUTION CUP



SAPLI SÜNGER
BETADINE SPONGE

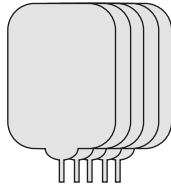

30 x 35 cm
UNIVERSAL TORBA
UNIVERSAL BAG

1 Çift/Pair -Large
CERRAHİ ELDİVEN
SURGICAL GLOVES

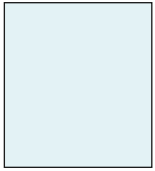
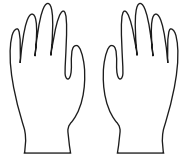

50 x 50 cm
STERİLİZASYON BOHÇASI
STERILIZATION WRAP



PLASTİK PENSET
FORCEPS

ALÜMİNYUM TEPSİ
ALUMINIUM TRAY

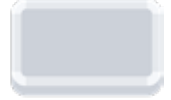

REF: MED-STRO08

Pansuman Örtü Seti

Dressing Drape Set

İÇERİK / CONTENT

EBAT / SIZE

ADET / PIECES

Delikli Yapışkan Bantlı Örtü
Fenestrated Drape With
Adhesive Tape

60 x 60 cm

1

Solüsyon Kabı
Solution Cup

250 cc

1

Solüsyon Sünger
Betadine Sponge

1

Universal Torba
Universal Bag

30 x 35 cm

5

Spanç
Gauze Swab

7,5 x 7,5 cm

5

Cerrahi Eldiven
Surgical Gloves

Large

1 Çift / Pair

Alüminyum Tepsi
Aluminium Tray

1

Havlu
Towel

40 x 40 cm

1

Sterilizasyon Bohçası
Sterilization Wrap

50 x 50 cm

1

Plastik PenSet
Forceps

1

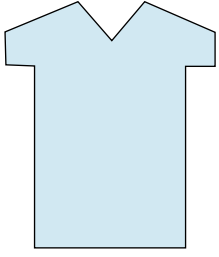

HASTA MUAYENE ÖNLÜĞÜ
PATIENT EXAMINATION GOWN

7,5 x 7,5 cm
SPANÇ
GAUZE SWAB

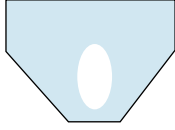

SÜNNET KÜLODU
CIRCUMCISION PANTIES



40 x 40 cm
HAVLU
TOWEL

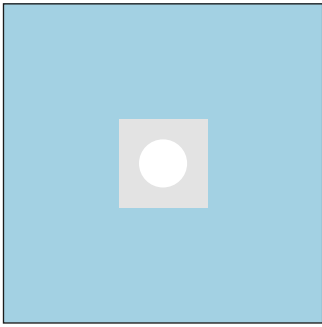

75 x 75 cm
SÜNNET ÖRTÜSÜ
CIRCUMCISION DRAPE

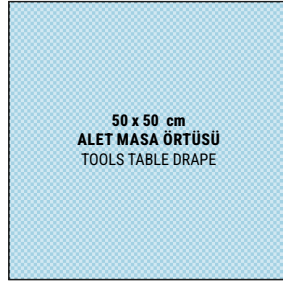

50 x 50 cm
ALET MASA ÖRTÜSÜ
TOOLS TABLE DRAPE



50 x 50 cm
STERİLİZASYON BOHÇASI
STERILIZATION WRAP

REF: MED-STR009

Sünnet Örtü Seti

Circumcision Drape Set

İÇERİK / CONTENT	EBAT / SIZE	ADET / PIECES
Sünnet Örtüsü Circumcision Drape	75 x 75 cm	1
Alet Masa Örtüsü Tools Table Drape	50 x 50 cm	1
Spanç Gauze Swab	7,5 x 7,5 cm	2
Hasta Muayene Önlüğü Patient Examination Gown	Standart	1
Havlu Towel	40 x 40 cm	1
Sünnet Külodu Circumcision Panties	Standart	1
Sterilizasyon Bohçası Sterilization Wrap	50 x 50 cm	1



Ortopedi Örtü Setleri

Orthopedic Drape Sets



10 x 50 cm
OP-TAPE
OP-TAPE

10 x 200 cm
ELASTİK BANDAJ
ELASTIC BANDAGE

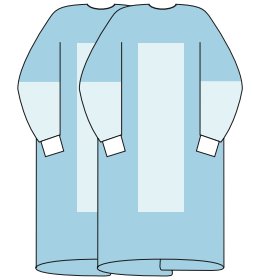

Large
TAKVİYELİ CERRAHİ ÖNLÜK
REINFORCED SURGICAL GOWN

40 x 75 cm
STOKINET (Bacak Kılıfı)
STOCKINETTE (For Leg)

CİLT KALEMİ & CETVEL
SKIN MARKER & RULER

13 x 250 cm
KAMERA KILIFI
VIDEO CAMERA COVER

40 x 40 cm
HAVLU
TOWEL

100 x 100 cm
STERİLİZASYON BOHÇASI
STERILIZATION WRAP

150 x 200 cm
ALET MASA ÖRTÜSÜ
TOOLS TABLE DRAPE



200 x 300 cm
ARTROSKOPİ ÖRTÜSÜ POŞLU
ARTHROSCOPY DRAPE WITH POUCH

REF: MED-STR010

Artroskopi Örtü Seti

Arthroscopy Drape Set

İÇERİK / CONTENT	EBAT / SIZE	ADET / PIECES
Artroskopi Örtüsü Poşlu Arthroscopy Drape With Pouch	200 x 300 cm	1
Alet Masa Örtüsü Tools Table Drape	150 x 200 cm	1
Stokinet (Bacak için) Stockinette (For Leg)	40 x 75 cm	1
Kamera Kılıfı Video Camera Cover	13 x 250 cm	1
Cilt Kalem ve Cetveli Skin Marker and Ruler		1
Elastik Bandaj Elastic Bandage	10 x 200 cm	1
Op-Tape Op-Tape	10 x 50 cm	2
Takviyeli Cerrahi Önlük Reinforced Surgical Gown	Large	2
Havlu Towel	40 x 40 cm	2
Sterilizasyon Bohçası Sterilization Wrap	100 x 100 cm	1



10 x 50 cm
OP-TAPE
OP-TAPE

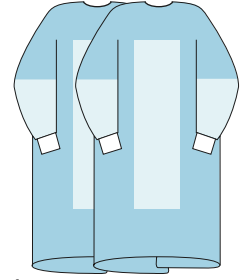

Large
TAKVİYELİ CERRAHİ ÖNLÜK
REINFORCED SURGICAL GOWN



CİLT KALEMİ & CETVEL
SKIN MARKER & RULER

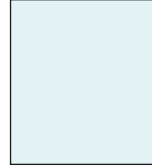

100 x 100 cm
STERİLİZASYON BOHÇASI
STERILIZATION WRAP

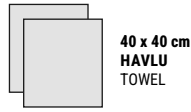

40 x 40 cm
HAVLU
TOWEL

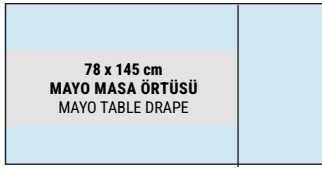

78 x 145 cm
MAYO MASA ÖRTÜSÜ
MAYO TABLE DRAPE



150 x 200 cm
ALET MASA ÖRTÜSÜ
TOOLS TABLE DRAPE

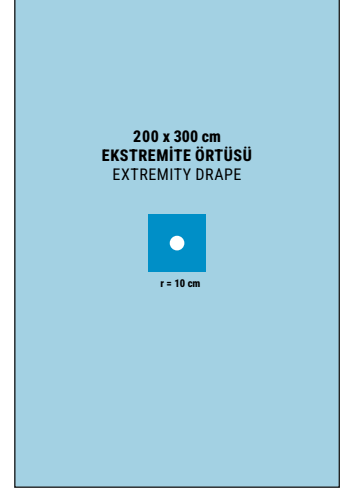

200 x 300 cm
EKSTREMİTE ÖRTÜSÜ
EXTREMITY DRAPE

r = 10 cm

REF: MED-STR011

Ekstremitte Örtü Seti

Extremity Drape Set

İÇERİK / CONTENT

EBAT / SIZE

ADET / PIECES

Ekstremitte Örtüsü
Extremity Drape

200 x 300 cm

1

Alet Masa Örtüsü
Tools Table Drape

150 x 200 cm

1

Mayo Masa Örtüsü
Mayo Table Drape

78 x 145 cm

1

Cilt Kalemi ve Cetveli
Skin Marker and Ruler

1

Takviyeli Cerrahi Önlük
Reinforced Surgical Gown

Large

2

Op-Tape
Op-Tape

10 x 50 cm

2

Havlu
Towel

40 x 40 cm

2

Sterilizasyon Bohçası
Sterilization Wrap

100 x 100 cm

1

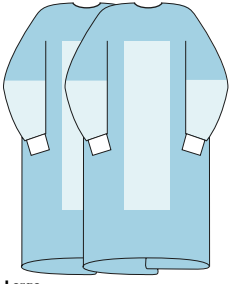

Large
TAKVİYELİ CERRAHİ ÖNLÜK
REINFORCED SURGICAL GOWN

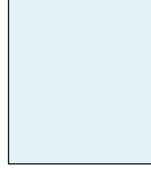

100 x 100 cm
STERİLİZASYON BOHÇASI
STERILIZATION WRAP

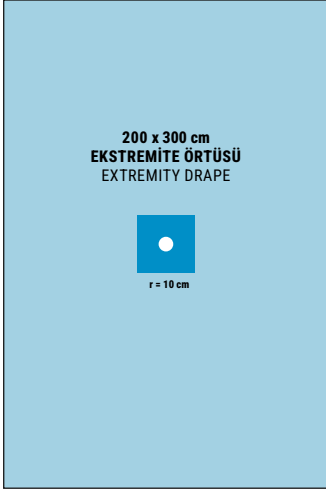

200 x 300 cm
EKSTREMİTE ÖRTÜSÜ
EXTREMITY DRAPE



100 x 150 cm
ALET MASA ÖRTÜSÜ
TOOLS TABLE DRAPE



78 x 145 cm
MAYO MASA ÖRTÜSÜ
MAYO TABLE DRAPE

REF: MED-STR012

El Cerrahi Örtü Seti Hand Surgical Drape Set

İÇERİK / CONTENT

EBAT / SIZE

ADET / PIECES

Üst Ekstremitte Örtüsü
Upper Extremity Drape

200 x 300 cm

1

Alet Masa Örtüsü
Tools Table Drape

100 x 150 cm

1

Mayo Masa Örtüsü
Mayo Table Drape

78 x 145 cm

1

Takviyeli Cerrahi Önlük
Reinforced Surgical Gown

Large

2

Sterilizasyon Bohçası
Sterilization Wrap

100 x 100 cm

1

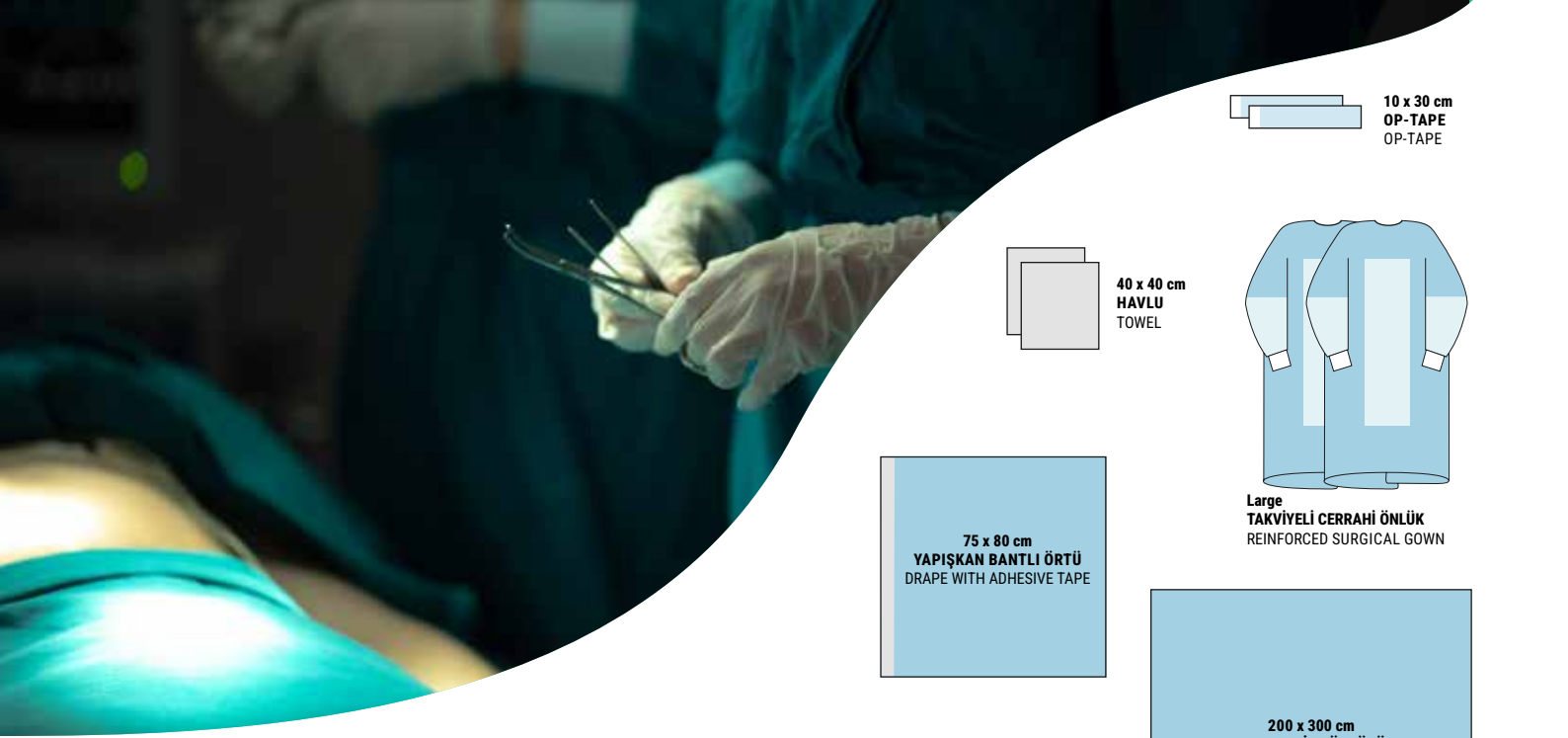

10 x 30 cm
OP-TAPE
OP-TAPE

40 x 40 cm
HAVLU
TOWEL

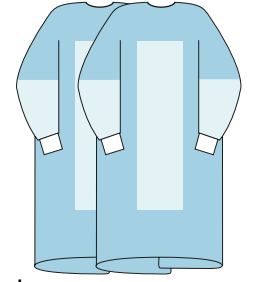

Large
TAKVİYELİ CERRAHİ ÖNLÜK
REINFORCED SURGICAL GOWN

75 x 80 cm
YAPIŞKAN BANTLI ÖRTÜ
DRAPE WITH ADHESIVE TAPE

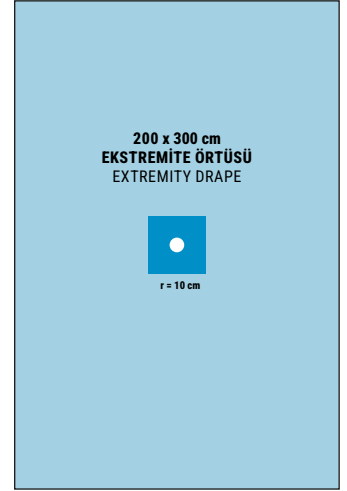

200 x 300 cm
EKSTREMİTE ÖRTÜSÜ
EXTREMITY DRAPE

r = 10 cm

100 x 100 cm
STERİLİZASYON BOHÇASI
STERILIZATION WRAP

78 x 145 cm
MAYO MASA ÖRTÜSÜ
MAYO TABLE DRAPE

100 x 150 cm
ALET MASA ÖRTÜSÜ
TOOLS TABLE DRAPE

REF: MED-STR013

Diz Örtü Seti Knee Drape Set

İÇERİK / CONTENT	EBAT / SIZE	ADET / PIECES
Ekstremitte Örtüsü Extremity Drape	200 x 300 cm	1
Yapışkan Bantlı Örtü Drape With Adhesive Tape	75 x 80 cm	1
Alet Masa Örtüsü Tools Table Drape	100 x 150 cm	1
Mayo Masa Örtüsü Mayo Table Drape	78 x 145 cm	1
Op-Tape Op-Tape	10 x 30 cm	2
Takviyeli Cerrahi Önlük Reinforced Surgical Gown	Large	2
Havlu Towel	40 x 40 cm	2
Sterilizasyon Bohçası Sterilization Wrap	100 x 100 cm	1

10 x 50 cm
OP-TAPE
OP-TAPE

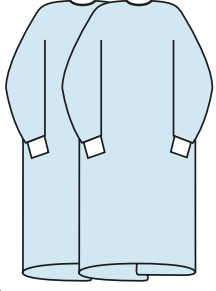

Large
STANDART CERRAHİ ÖNLÜK
STANDART SURGICAL GOWN

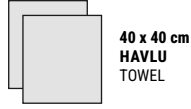

40 x 40 cm
HAVLU
TOWEL

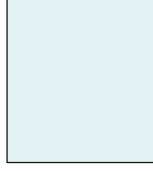

100 x 100 cm
STERİLİZASYON BOHÇASI
STERILIZATION WRAP

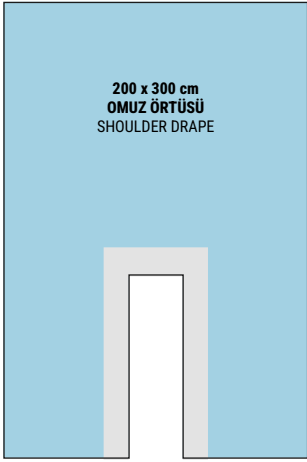

200 x 300 cm
OMUZ ÖRTÜSÜ
SHOULDER DRAPE



78 x 145 cm
MAYO MASA ÖRTÜSÜ
MAYO TABLE DRAPE

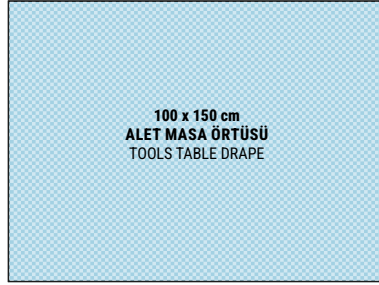

100 x 150 cm
ALET MASA ÖRTÜSÜ
TOOLS TABLE DRAPE



75 x 100 cm
YAPIŞKAN BANTLI ÖRTÜ
DRAPE WITH ADHESIVE TAPE

REF: MED-STR014

Omuz Örtü Seti

Shoulder Surgical Drape Set

İÇERİK / CONTENT

EBAT / SIZE

ADET / PIECES

Omuz Örtüsü
Shoulder Drape

200 x 300 cm

1

Yapışkan Bantlı Örtü
Drape With Adhesive Tape

75 x 100 cm

1

Alet Masa Örtüsü
Tools Table Drape

100 x 150 cm

1

Mayo Masa Örtüsü
Mayo Table Drape

78 x 145 cm

1

Op-Tape
Op-Tape

10 x 50 cm

2

Standart Cerrahi Önlük
Standart Surgical Gown

Large

2

Havlu
Towel

40 x 40 cm

2

Sterilizasyon Bohçası
Sterilization Wrap

100 x 100 cm

1

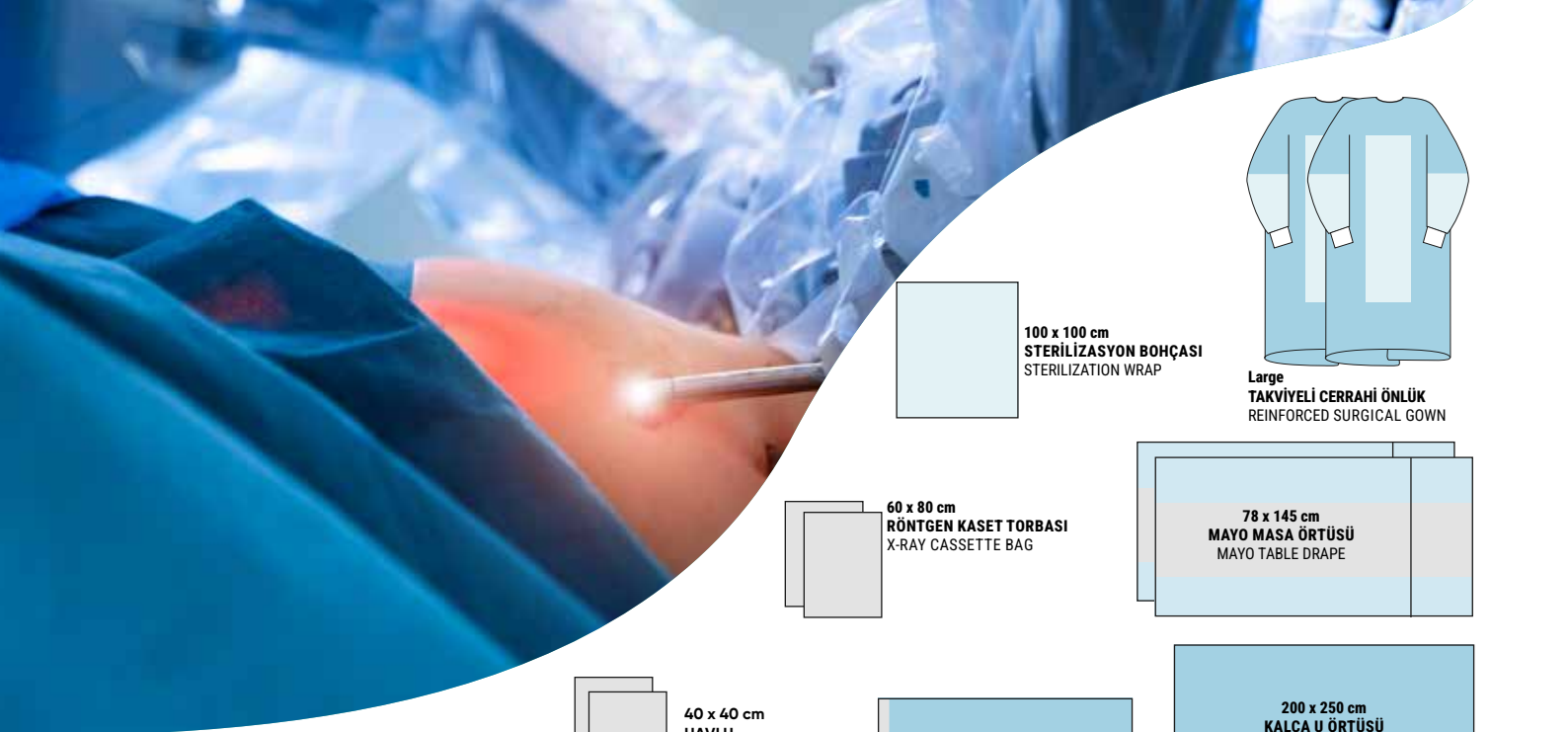

100 x 100 cm
STERİLİZASYON BOHÇASI
STERILIZATION WRAP

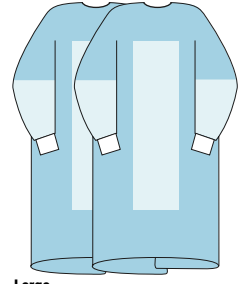

Large
TAKVİYELİ CERRAHİ ÖNLÜK
REINFORCED SURGICAL GOWN

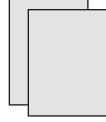

60 x 80 cm
RÖNTGEN KASET TORBASİ
X-RAY CASSETTE BAG

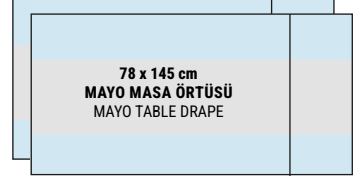

78 x 145 cm
MAYO MASA ÖRTÜSÜ
MAYO TABLE DRAPE

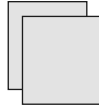

40 x 40 cm
HAVLU
TOWEL

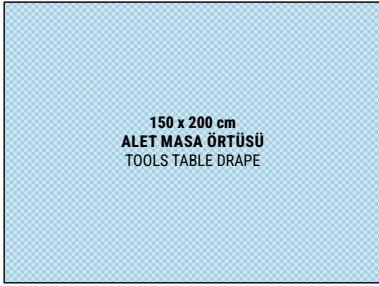

150 x 200 cm
ALET MASA ÖRTÜSÜ
TOOLS TABLE DRAPE



150 x 180 cm
BANTLI AYAK ÖRTÜSÜ
LEG DRAPE WITH ADHESIVE
TAPE



200 x 300 cm
BANTLI ANESTEZİ ÖRTÜSÜ
ANESTHESIA DRAPE WITH
ADHESIVE TAPE

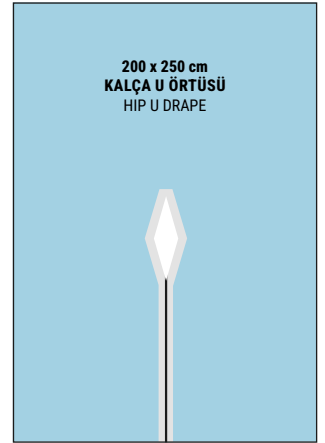

200 x 250 cm
KALÇA U ÖRTÜSÜ
HIP U DRAPE

REF: MED-STR015

Artroplasti (Kalça) Örtü Seti

Arthroplasty (Hip) Drape Set

İÇERİK / CONTENT

EBAT / SIZE

ADET / PIECES

Kalça U Örtüsü Hip U Drape	200 x 250 cm	1
Bantlı Anestezi Örtüsü Anesthesia Drape With Adhesive Tape	200 x 300 cm	1
Bantlı Ayak Örtüsü Leg Drape With Adhesive Tape	150 x 180 cm	1
Alet Masa Örtüsü Tools Table Drape	150 x 200 cm	1
Mayo Masa Örtüsü Mayo Table Drape	78 x 145 cm	2
Takviyeli Cerrahi Önlük Reinforced Surgical Gown	Large	2
Havlu Towel	40 x 40 cm	2
Röntgen Kaset Torbası X-Ray Cassette Bag	60 x 80 cm	2
Sterilizasyon Bohçası Sterilization Wrap	100 x 100 cm	1

10 x 50 cm
OP-TAPE
OP-TAPE

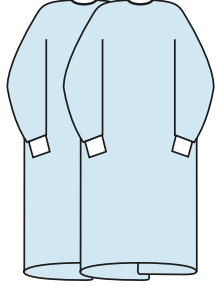

Large
STANDART CERRAHİ ÖNLÜK
STANDART SURGICAL GOWN

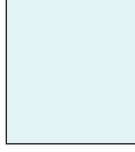

100 x 100 cm
STERİLİZASYON BOHÇASI
STERILIZATION WRAP

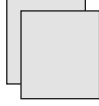

40 x 40 cm
HAVLU
TOWEL



78 x 145 cm
MAYO MASA ÖRTÜSÜ
MAYO TABLE DRAPE

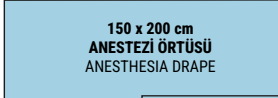

150 x 200 cm
ANESTEZİ ÖRTÜSÜ
ANESTHESIA DRAPE

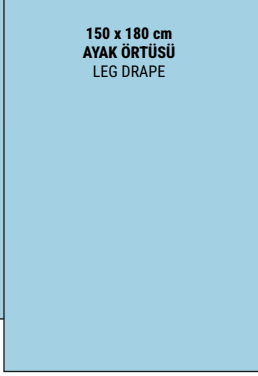

150 x 180 cm
AYAK ÖRTÜSÜ
LEG DRAPE



100 x 120 cm
YAPIŞKAN BANTLI ÖRTÜ
DRAPE WITH ADHESIVE TAPE

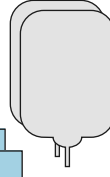

50 x 60 cm
UNIVERSAL TORBA
UNIVERSAL BAG



70 x 100 cm
YAPIŞKAN BANTLI ÖRTÜ
DRAPE WITH ADHESIVE TAPE



CİLT KALEMİ & CETVEL
SKIN MARKER & RULER



150 x 200 cm
ALET MASA ÖRTÜSÜ
TOOLS TABLE DRAPE

REF: MED-STR016

Vertebra Örtü Seti

Vertebra Surgical Drape Set

İÇERİK / CONTENT

EBAT / SIZE

ADET / PIECES

Anestesi Örtüsü Anesthesia Drape	150 x 200 cm	1
Ayak Örtüsü Leg Drape	150 x 180 cm	1
Alet Masa Örtüsü Tools Table Drape	150 x 200 cm	1
Mayo Masa Örtüsü Mayo Table Drape	78 x 145 cm	1
Yapışkan Bantlı Örtü Drape With Adhesive Tape	100 x 120 cm	2
Yapışkan Bantlı Örtü Drape With Adhesive Tape	75 x 100 cm	2
Op-Tape Op-Tape	10 x 50 cm	2
Cilt Kalemi ve Cetveli Skin Marker and Ruler		1
Standart Cerrahi Önlük Standart Surgical Gown	Large	2
Universal Torba Universal Bag	50 x 60 cm	2
Havlu Towel	40 x 40 cm	2
Sterilizasyon Bohçası Sterilization Wrap	100 x 100 cm	1



Kardiyoloji Örtü Setleri Cardiology Drape Sets

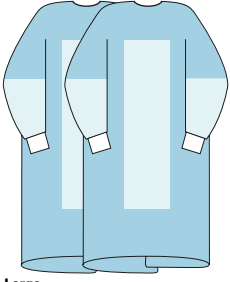

Large
TAKVİYELİ CERRAHİ ÖNLÜK
REINFORCED SURGICAL GOWN



500 cc
SOLÜSYON KABI
SOLUTION CUP



250 cc
SOLÜSYON KABI
SOLUTION CUP



7,5 x 7,5 cm
SPANÇ
GAUZE SWAB

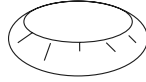

FLOROSKOPİ KILIFI
FLUOROSCOPY COVER



150 x 240 cm
ANJİYO ÖRTÜSÜ
ANGIOGRAPHY DRAPE

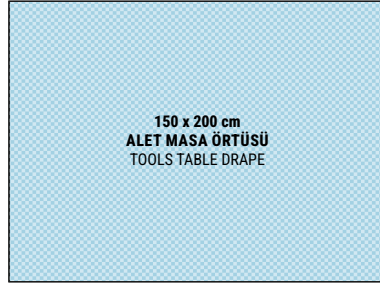

150 x 200 cm
ALET MASA ÖRTÜSÜ
TOOLS TABLE DRAPE



1000 cc
TEPSİ
TRAY



100 x 100 cm
STERİLİZASYON BOHÇASI
STERILIZATION WRAP

BOYAMA SÜNGERİ
BETADINE SPONGE

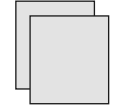

40 x 40 cm
HAVLU
TOWEL

REF: MED-STR017

Anjiyografi Örtü Seti

Angiography Drape Set

İÇERİK / CONTENT

EBAT / SIZE

ADET / PIECES

Anjiyo Örtüsü
Angiography Drape

150 x 240 cm

1

Alet Masa Örtüsü
Tools Table Drape

150 x 200 cm

1

Spanç
Gauze Swab

7,5 x 7,5 cm

10

Boyama Sünger
Betadine Sponge

1

Solüsyon Kabi
Solution Cup

250 cc / 500 cc

1 / 1

Tepsi
Tray

1000 cc

1

Floroskopi Kılıfı
Fluoroscopy Cover

85 x 85 cm

1

Takviyeli Cerrahi Önlük
Reinforced Surgical Gown

Large

2

Havlu
Towel

40 x 40 cm

2

Sterilizasyon Bohçası
Sterilization Wrap

100 x 100 cm

1



7,5 x 7,5 cm
SPANÇ
GAUZE SWAB

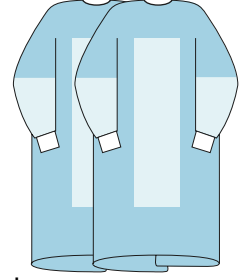

Large
TAKVİYELİ CERRAHİ ÖNLÜK
REINFORCED V GOWN



500 cc
SOLÜSYON KABI
SOLUTION CUP



250 cc
SOLÜSYON KABI
SOLUTION CUP

BOYAMA SÜNGERİ
BETADINE SPONGE



FLOROSKOPİ KILIFI
FLUOROSCOPY COVER



1000 cc
TEPSİ
TRAY



100 x 100 cm
STERİLİZASYON BOHÇASI
STERILIZATION WRAP



40 x 40 cm
HAVLU
TOWEL



150 x 200 cm
ALET MASA ÖRTÜSÜ
TOOLS TABLE DRAPE

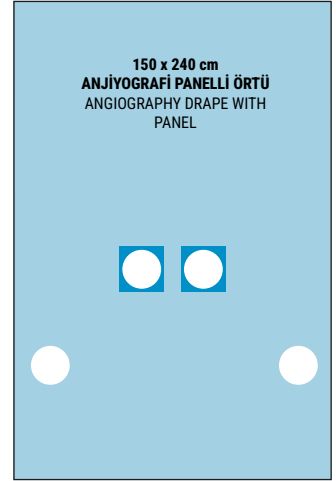

150 x 240 cm
ANJİYOĞRAFI PANELLİ ÖRTÜ
ANGIOGRAPHY DRAPE WITH
PANEL

REF: MED-STR018

Anjiyografi Panelli Örtü Seti

Angiography Drape With Panel Set

İÇERİK / CONTENT

EBAT / SIZE

ADET / PIECES

Anjiyografi Panelli Örtüsü
Angiography Drape With Panel

150 x 240 cm

1

Alet Masa Örtüsü
Tools Table Drape

150 x 200 cm

1

Spanç
Gauze Swab

7,5 x 7,5 cm

10

Boyama Süngeri
Betadine Sponge

1

Solüsyon Kabi
Solution Cup

250cc / 500 cc

1 / 1

Tepsi
Tray

1000 cc

1

Floroskopi Kılıfı
Fluoroscopy Cover

85 x 85 cm

1

Takviyeli Cerrahi Önlük
Reinforced Surgical Gown

Large

2

Havlu
Towel

40 x 40 cm

2

Sterilizasyon Bohçası
Sterilization Wrap

100 x 100 cm

1

10 x 50 cm
OP-TAPE
OP-TAPE

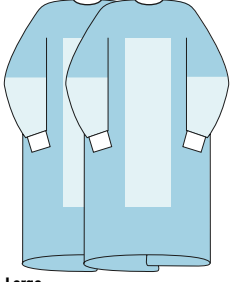

Large
TAKVİYELİ CERRAHİ ÖNLÜK
REINFORCED SURGICAL GOWN

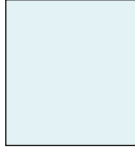

100 x 100 cm
STERİLİZASYON BOHÇASI
STERILIZATION WRAP



78 x 145 cm
MAYO MASA ÖRTÜSÜ
MAYO TABLE DRAPE

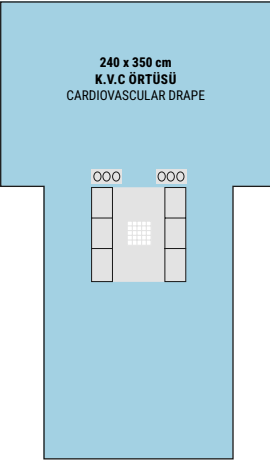

240 x 350 cm
K.V.C ÖRTÜSÜ
CARDIOVASCULAR DRAPE

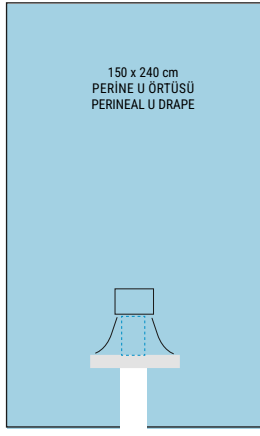

150 x 240 cm
PERİNE U ÖRTÜSÜ
PERINEAL U DRAPE



Standart
AYAKLIK
LEGGINS

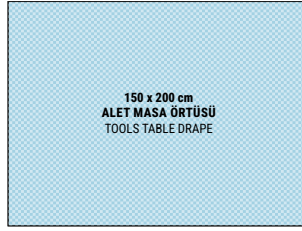

150 x 200 cm
ALET MASA ÖRTÜSÜ
TOOLS TABLE DRAPE

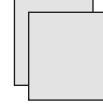

40 x 40 cm
HAVLU
TOWEL

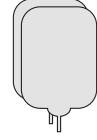

30 x 36 cm
UNIVERSAL TORBA
UNIVERSAL BAG

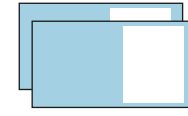

40 x 60 cm
STOKINET
STOCKINETE

REF: MED-STR019

BY-PASS Örtü Seti

BY-PASS Drape Set

İÇERİK / CONTENT	EBAT / SIZE	ADET / PIECES
K.V.C. Örtüsü Cardiovascular Drape	240 x 350 cm	1
Perine U Örtüsü Perineal U Drape	150 x 240 cm	1
Alet Masa Örtüsü Tools Table Drape	150 x 200 cm	1
Mayo Masa Örtüsü Mayo Table Drape	78 x 145 cm	1
Stokinet Stockinette	40 x 60 cm	2
Ayaklık Leggins	Standart	2
Op-Tape Op-Tape	10 x 50 cm	2
Universal Torba Universal Bag	30 x 36 cm	2
Takviyeli Cerrahi Önlük Reinforced Surgical Gown	Large	2
Havlu Towel	40 x 40 cm	2
Sterilizasyon Bohçası Sterilization Wrap	100 x 100 cm	1



10 x 30 cm
OP-TAPE
OP-TAPE



100 x 100 cm
STERİLİZASYON BOHÇASI
STERILIZATION WRAP

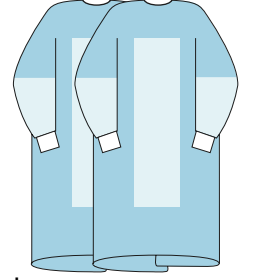

Large
TAKVİYELİ CERRAHİ ÖNLÜK
REINFORCED SURGICAL GOWN



40 x 40 cm
HAVLU
TOWEL



30 x 35 cm
UNIVERSAL TORBA
UNIVERSAL BAG



78 x 145 cm
MAYO MASA ÖRTÜSÜ
MAYO TABLE DRAPE

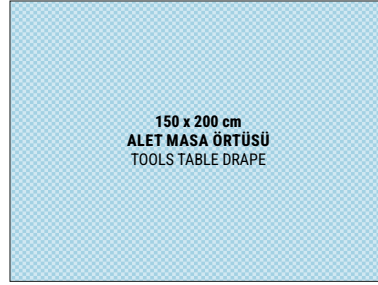

150 x 200 cm
ALET MASA ÖRTÜSÜ
TOOLS TABLE DRAPE

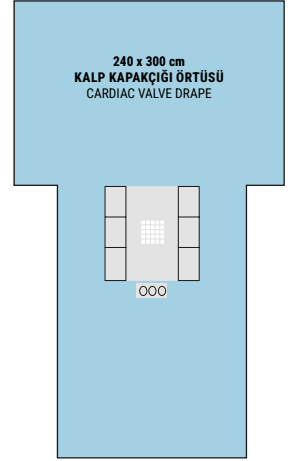

240 x 300 cm
KALP KAPAKÇIĞI ÖRTÜSÜ
CARDIAC VALVE DRAPE

REF: MED-STRO20

Kalp Kapakçığı Örtü Seti

Cardiac Valve Drape Set

İÇERİK / CONTENT

EBAT / SIZE

ADET / PIECES

Kalp Kapakçığı Örtüsü
Cardiac Valve Drape Set

240 x 300 cm

1

Alet Masa Örtüsü
Tools Table Drape

150 x 200 cm

1

Mayo Masa Örtüsü
Mayo Table Drape

78 x 145 cm

1

Universal Torba
Universal Bag

30 x 36 cm

2

Op-Tape
Op-Tape

10 x 30 cm

2

Takviyeli Cerrahi Önlük
Reinforced Surgical Gown

Large

2

Havlu
Towel

40 x 40 cm

2

Sterilizasyon Bohçası
Sterilization Wrap

100 x 100 cm

1

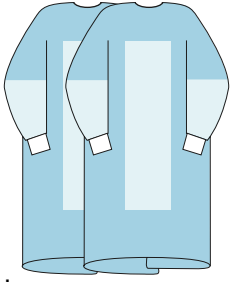

Large
TAKVİYELİ CERRAHİ ÖNLÜK
REINFORCED SURGICAL GOWN

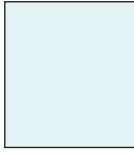

100 x 100 cm
STERİLİZASYON BOHÇASI
STERILIZATION WRAP

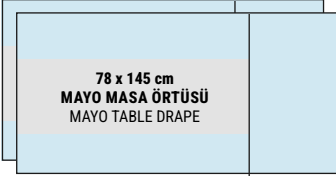

78 x 145 cm
MAYO MASA ÖRTÜSÜ
MAYO TABLE DRAPE

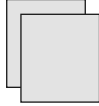

40 x 40 cm
HAVLU
TOWEL



200 x 150 cm
YAPIŞKAN BANTLI ÖRTÜ
DRAPE WITH ADHESIVE TAPE

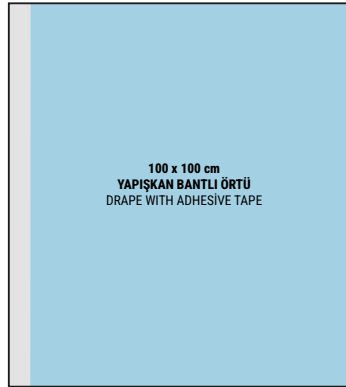

100 x 100 cm
YAPIŞKAN BANTLI ÖRTÜ
DRAPE WITH ADHESIVE TAPE

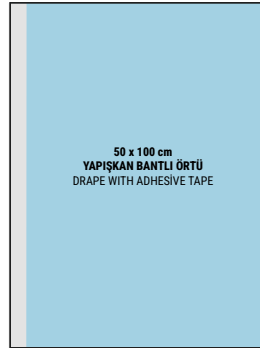

50 x 100 cm
YAPIŞKAN BANTLI ÖRTÜ
DRAPE WITH ADHESIVE TAPE

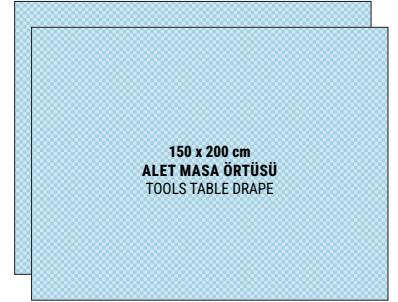

150 x 200 cm
ALET MASA ÖRTÜSÜ
TOOLS TABLE DRAPE

REF: MED-STR021

Kardiyovasküler Örtü Seti

Cardiovascular Drape Set

İÇERİK / CONTENT	EBAT / SIZE	ADET / PIECES
Yapışkan Bantlı Örtü Drape With Adhesive Tape	50 x 100 cm	1
Yapışkan Bantlı Örtü Drape With Adhesive Tape	100 x 100 cm	1
Yapışkan Bantlı Örtü Drape With Adhesive Tape	200 x 150 cm	1
Alet Masa Örtüsü Tools Table Drape	150 x 200 cm	2
Mayo Masa Örtüsü Mayo Table Drape	78 x 145 cm	2
Takviyeli Cerrahi Önlük Reinforced Surgical Gown	Large	2
Havlu Towel	40 x 40 cm	2
Sterilizasyon Bohçası Sterilization Wrap	100 x 100 cm	1



Jinekoloji Örtü Setleri Gynecology Drape Sets

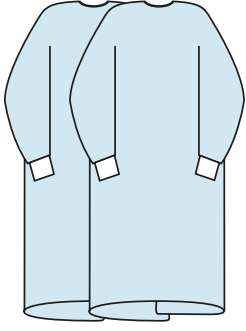

Large
STANDART CERRAHİ ÖNLÜK
STANDART SURGICAL GOWN

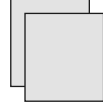

40 x 40 cm
HAVLU
TOWEL



7,5 x 7,5 cm
SPANÇ
GAUZE SWAB

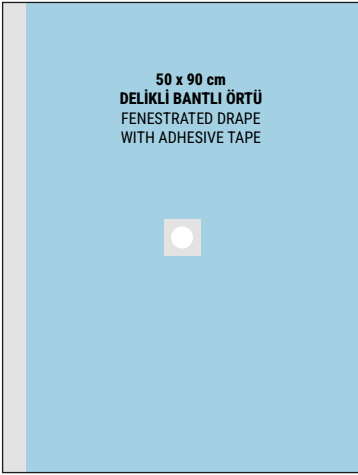

50 x 90 cm
DELİKLİ BANTLI ÖRTÜ
FENESTRATED DRAPE
WITH ADHESIVE TAPE

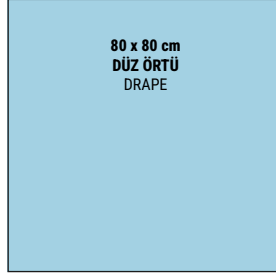

80 x 80 cm
DÜZ ÖRTÜ
DRAPE

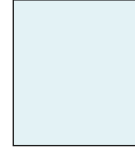

100 x 100 cm
STERİLİZASYON BOHÇASI
STERILIZATION WRAP

REF: MED-STRO22

Embriyo Transfer Örtü Seti

Embryo Transfer Drape Set

İÇERİK / CONTENT

EBAT / SIZE

ADET / PIECES

Delikli Bantlı Örtü
Fenestrated Drape With
Adhesive Tape

50 x 90 cm

1

Düz Örtü
Drape

80 x 80 cm

1

Spanç
Gauze Swab

7,5 x 7,5 cm

10

Standart Cerrahi Önlük
Standard Surgical Gown

Large

2

Havlu
Towel

40 x 40 cm

2

Sterilizasyon Bohçası
Sterilization Wrap

100 x 100 cm

1



7,5 x 7,5 cm
SPANÇ
GAUZE SWAB

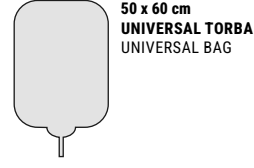

50 x 60 cm
UNIVERSAL TORBA
UNIVERSAL BAG



13 x 250 cm
KAMERA KILIFI
VIDEO CAMERA COVER

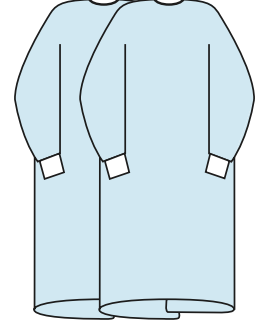

Large
STANDART CERRAHİ ÖNLÜK
STANDART SURGICAL GOWN



100 x 100 cm
STERİLİZASYON BOHÇASI
STERILIZATION WRAP

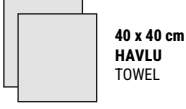

40 x 40 cm
HAVLU
TOWEL



50 x 120 cm
BACAK KILIFI
LEG COVER



150 x 200 cm
ALET MASA ÖRTÜSÜ
TOOLS TABLE DRAPE

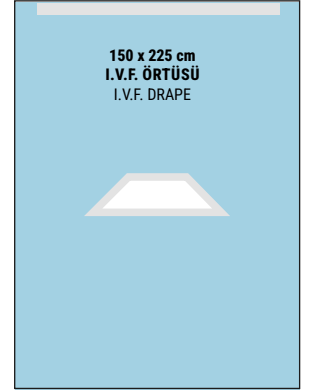

150 x 225 cm
I.V.F. ÖRTÜSÜ
I.V.F. DRAPE

REF: MED-STRO23

I.V.F. (Tüp Bebek) Örtü Seti

I.V.F. Drape Set

İÇERİK / CONTENT

EBAT / SIZE

ADET / PIECES

I.V.F. Örtüsü
I.V.F. Drape

150 x 225 cm

1

Alet Masa Örtüsü
Tools Table Drape

100 x 150 cm

1

Bacak Kılıfı
Leg Cover

50 x 120 cm

2

Spanç
Gauze Swab

7,5 x 7,5 cm

10

Kamera Kılıfı
Video Camera Cover

13 x 250 cm

1

Universal Torba
Universal Bag

50 x 60 cm

1

Standart Cerrahi Önlük
Standart Surgical Gown

Large

2

Havlu
Towel

40 x 40 cm

2

Sterilizasyon Bohçası
Sterilization Wrap

100 x 100 cm

1

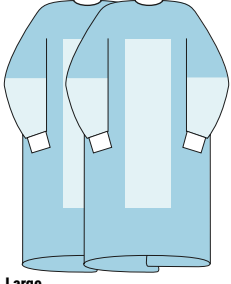

Large
TAKVİYELİ CERRAHİ ÖNLÜK
REINFORCED SURGICAL GOWN



80 x 80 cm
BEBEK ÖRTÜSÜ
BABY DRAPE



100 x 100 cm
STERİLİZASYON BOHÇASI
STERILIZATION WRAP

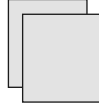

40 x 40 cm
HAVLU
TOWEL



GÖBEK KLEMPİ
UMBILICAL CORD
CLAMP



75 x 150 cm
YAPIŞKAN BANTLI ÖRTÜ
DRAPE WITH ADHESIVE



75 x 100 cm
DÜZ ÖRTÜ
DRAPE

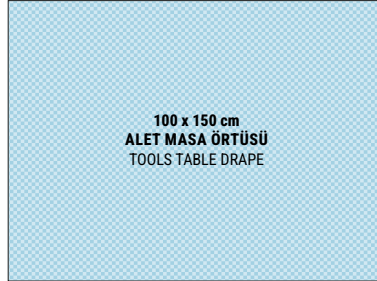

100 x 150 cm
ALET MASA ÖRTÜSÜ
TOOLS TABLE DRAPE



60 x 120 cm
BACAK KILIFI
LEG COVER

REF: MED-STRO24

Doğum Örtü Seti Maternity Drape Set

İÇERİK / CONTENT	EBAT / SIZE	ADET / PIECES
Yapışkan Bantlı Örtü Drape With Adhesive Tape	75 x 150 cm	1
Bebek Örtüsü Baby Drape	80 x 80 cm	1
Alet Masa Örtüsü Tools Table Drape	100 x 150 cm	1
Düz Örtü Drape	75 x 100 cm	1
Bacak Kılıfı Leg Cover	60 x 120 cm	2
Takviyeli Cerrahi Önlük Reinforced Surgical Gown	Large	2
Havlu Towel	40 x 40 cm	2
Göbek Klempİ Umbilical Cord Clamp	Standart	1
Sterilizasyon Bohçası Sterilization Wrap	100 x 100 cm	1

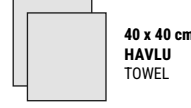

40 x 40 cm
HAVLU
TOWEL

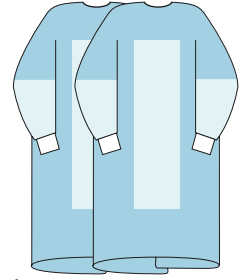

Large
TAKVİYELİ CERRAHİ ÖNLÜK
REINFORCED SURGICAL GOWN



80 x 80 cm
BEBEK ÖRTÜSÜ
BABY DRAPE

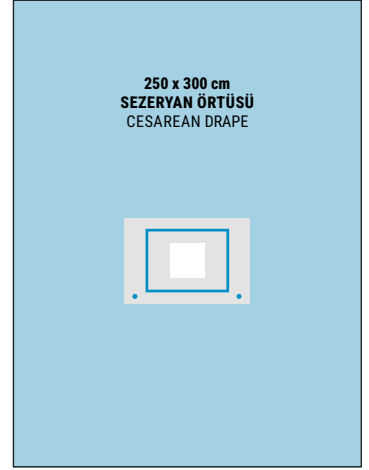

250 x 300 cm
SEZERYAN ÖRTÜSÜ
CESAREAN DRAPE



GÖBEK KLEMPİ
UMBILICAL CORD
CLAMP

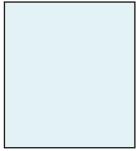

100 x 100 cm
STERİLİZASYON BOHÇASI
STERILIZATION WRAP



150 x 200 cm
ALET MASA ÖRTÜSÜ
TOOLS TABLE DRAPE

REF: MED-STRO25

Sezeryan Örtü Seti 1

Cesarean Drape Set 1

İÇERİK / CONTENT

EBAT / SIZE

ADET / PIECES

Sezeryan Örtüsü
Cesarean Drape

250 x 300 cm

1

Alet Masa Örtüsü
Tools Table Drape

150 x 200 cm

1

Bebek Örtüsü
Baby Drape

80 x 80 cm

1

Takviyeli Cerrahi Önlük
Reinforced Surgical Gown

Large

2

Göbek Klempİ
Umbilical Cord Clamp

Standart

1

Havlu
Towel

40 x 40 cm

2

Sterilizasyon Bohçası
Sterilization Wrap

100 x 100 cm

1

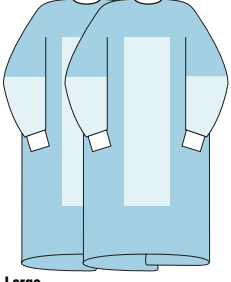

Large
TAKVİYELİ CERRAHİ ÖNLÜK
REINFORCED SURGICAL GOWN

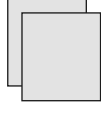

40 x 40 cm
HAVLU
TOWEL

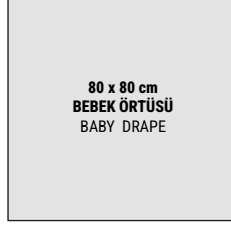

80 x 80 cm
BEBEK ÖRTÜSÜ
BABY DRAPE



250 x 300 cm
SEZERYAN ÖRTÜSÜ
CESAREAN DRAPE

30 x 30 cm

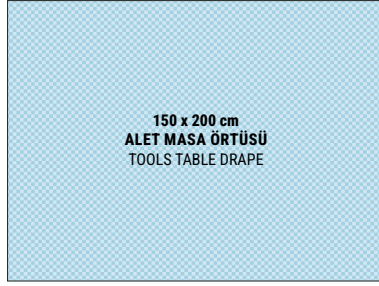

150 x 200 cm
ALET MASA ÖRTÜSÜ
TOOLS TABLE DRAPE



GÖBEK KLEMPİ
UMBILICAL CORD
CLAMP

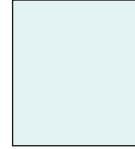

100 x 100 cm
STERİLİZASYON BOHÇASI
STERILIZATION WRAP

REF: MED-STRO26

Sezeryan Örtü Seti 2 Cesarean Drape Set 2

İÇERİK / CONTENT

EBAT / SIZE

ADET / PIECES

Sezeryan Örtüsü
Cesarean Drape

250 x 300 cm

1

Alet Masa Örtüsü
Tools Table Drape

150 x 200 cm

1

Bebek Örtüsü
Baby Drape

80 x 80 cm

1

Takviyeli Cerrahi Önlük
Reinforced Surgical Gown

Large

2

Göbek Klempİ
Umbilical Cord Clamp

Standart

1

Havlu
Towel

40 x 40 cm

2

Sterilizasyon Bohçası
Sterilization Wrap

100 x 100 cm

1



7,5 x 7,5 cm
SPANÇ
GAUZE SWAB

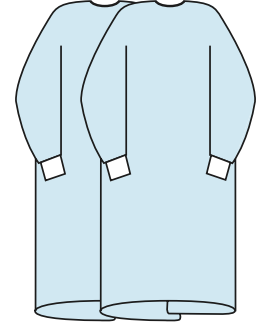

Large
STANDART CERRAHİ ÖNLÜK
STANDART SURGICAL GOWN

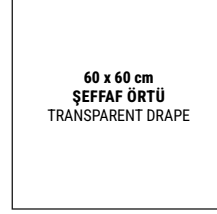

60 x 60 cm
ŞEFFAF ÖRTÜ
TRANSPARENT DRAPE

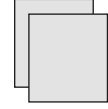

40 x 40 cm
HAVLU
TOWEL

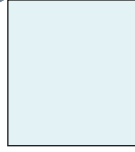

100 x 100 cm
STERİLİZASYON BOHÇASI
STERILIZATION WRAP



60 x 120 cm
BACAK KILIFI
LEG COVER

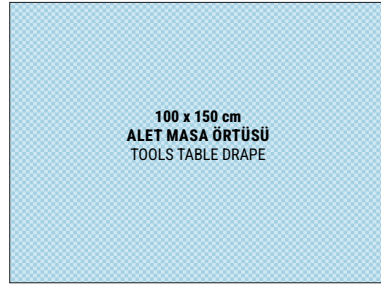

100 x 150 cm
ALET MASA ÖRTÜSÜ
TOOLS TABLE DRAPE

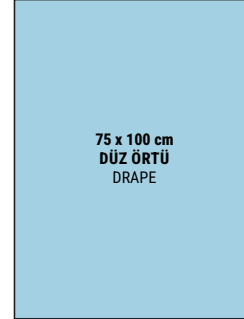

75 x 100 cm
DÜZ ÖRTÜ
DRAPE

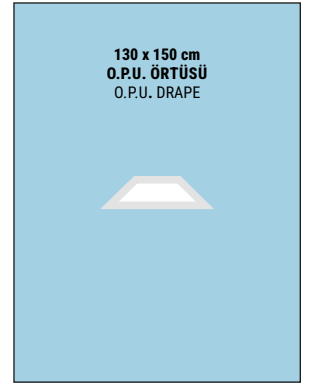

130 x 150 cm
O.P.U. ÖRTÜSÜ
O.P.U. DRAPE

REF: MED-STRO27

O.P.U Örtü Seti

O.P.U. Drape Set

İÇERİK / CONTENT

EBAT / SIZE

ADET / PIECES

O.P.U. Örtüsü
O.P.U Drape

130 x 150 cm

1

Düz Örtü
Drape

75 x 100 cm

1

Şeffaf Örtü
Transparent Drape

60 x 60 cm

1

Alet Masa Örtüsü
Tools Table Drape

100 x 150 cm

1

Bacak Kılıfı
Leg Cover

60 x 120 cm

2

Standart Cerrahi Önlük
Standard Surgical Gown

Large

2

Spanç
Gauze Swab

7,5 x 7,5 cm

10

Havlu
Towel

40 x 40 cm

2

Sterilizasyon Bohçası
Sterilization Wrap

100 x 100 cm

1

240 x 240 cm
LİTOTOMİK JİNEKOLOJİ ÖRTÜSÜ
LITHOTOMICAL GYNECOLOGY DRAPE



40 x 40 cm
HAVLU
TOWEL

100 x 150 cm
ALET MASA ÖRTÜSÜ
TOOLS TABLE DRAPE

75 x 75 cm
STERİLİZASYON BOHÇASI
STERILIZATION WRAP

2,5 x 30 cm
TÜP TUTUCU(BANTLI CİRTLİ)
TUBE HOLDER (WITH TAPE AND VELCRO)

REF: MED-STRO28

Litotomi Örtü Seti

Lithotomy Drape Set

İÇERİK / CONTENT

EBAT / SIZE

ADET / PIECES

Litotomik Jinekoloji Örtüsü
Lithotomical Gynecology Drape

240 x 240 cm

1

Tüp Tutucu(Bantlı Cırtlı)
Tube Holder

2,5 x 30 cm

1

Alet Masa Örtüsü
Tools Table Drape

100 x 150 cm

1

Havlu
Towel

40 x 40 cm

1

Sterilizasyon Bohçası
Sterilization Wrap

75 x 75 cm

1



Beyin Cerrahi Örtü Setleri Neurosurgery Drape Sets

10 x 50 cm
OP-TAPE
OP-TAPE

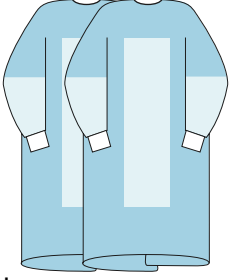

Large
TAKVİYELİ CERRAHİ ÖNLÜK
REINFORCED SURGICAL GOWN



100 x 100 cm
STERİLİZASYON BOHÇASI
STERILIZATION WRAP

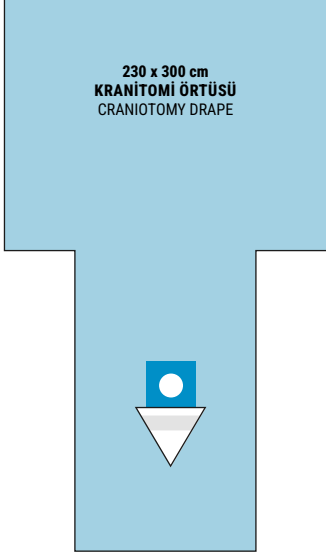

230 x 300 cm
KRANİTOMİ ÖRTÜSÜ
CRANIOTOMY DRAPE

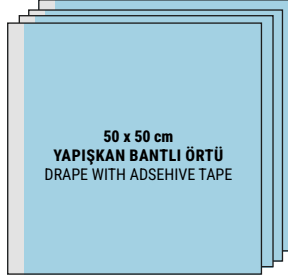

50 x 50 cm
YAPIŞKAN BANTLI ÖRTÜ
DRAPE WITH ADSEHIVE TAPE

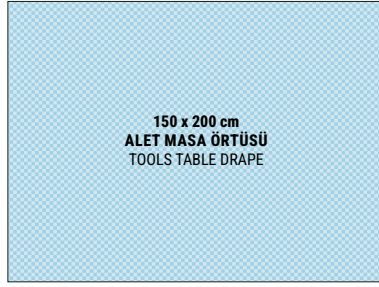

150 x 200 cm
ALET MASA ÖRTÜSÜ
TOOLS TABLE DRAPE

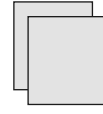

40 x 40 cm
HAVLU
TOWEL



78 x 145 cm
MAYO MASA ÖRTÜSÜ
MAYO TABLE DRAPE

REF: MED-STR029

Kraniyotomi Örtü Seti Craniotomy Drape Set

İÇERİK / CONTENT

EBAT / SIZE

ADET / PIECES

Kraniyotomi Örtüsü
Craniotomy Drape

230 x 300 cm

1

Mayo Masa Örtüsü
Mayo Table Drape

78 x 145 cm

1

Op-Tape
Op-Tape

10 x 50 cm

2

Yapışkan Bantlı Örtü
Drape With Adhesive Tape

50 x 50 cm

4

Alet Masa Örtüsü
Tools Table Drape

150 x 200 cm

1

Takviyeli Cerrahi Önlük
Reinforced Surgical Gown

Large

2

Havlu
Towel

40 x 40 cm

2

Sterilizasyon Bohçası
Sterilization Wrap

100 x 100 cm

1

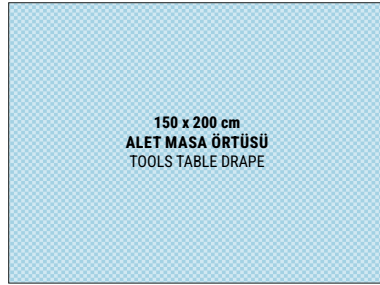
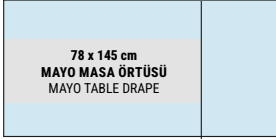
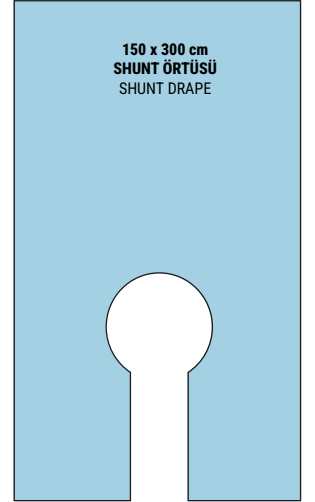
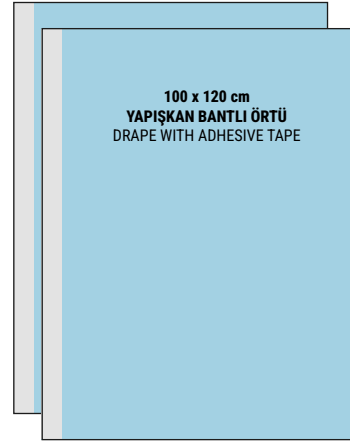
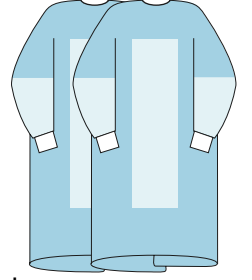

REF: MED-STRO30

Shunt Örtü Seti

Shunt Drape Set

İÇERİK / CONTENT

EBAT / SIZE

ADET / PIECES

Shunt Örtüsü
Shunt Drape

150 x 300 cm

1

Alet Masa Örtüsü
Tools Table Drape

150 x 200 cm

1

Mayo Masa Örtüsü
Mayo Table Drape

78 x 145 cm

1

Yapışkan Bantlı Örtü
Drape With Adhesive Tape

100 x 120 cm

2

Takviyeli Cerrahi Önlük
Reinforced Surgical Gown

Large

2

Havlu
Towel

40 x 40 cm

2

Sterilizasyon Bohçası
Sterilization Wrap

100 x 100 cm

1

10 x 50 cm
OP-TAPE
OP-TAPE

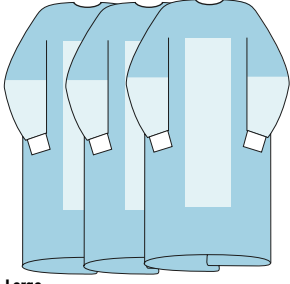

Large
TAKVİYELİ CERRAHİ ÖNLÜK
REINFORCED SURGICAL GOWN

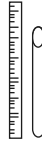

CİLT KALEMİ & CETVEL
SKIN MARKER & RULER

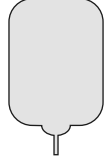

50 x 60 cm
UNIVERSAL TORBA
UNIVERSAL BAG

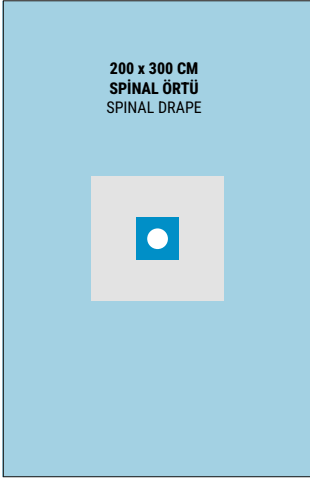

200 x 300 CM
SPİNAL ÖRTÜ
SPINAL DRAPE

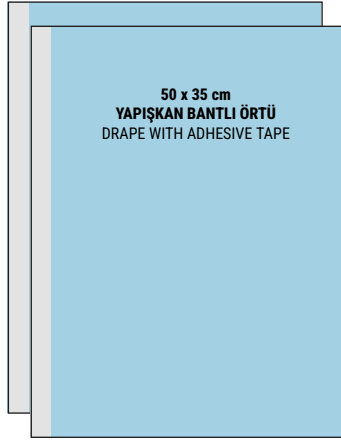

50 x 35 cm
YAPIŞKAN BANTLI ÖRTÜ
DRAPE WITH ADHESIVE TAPE



100 x 100 cm
STERİLİZASYON BOHÇASI
STERILIZATION WRAP

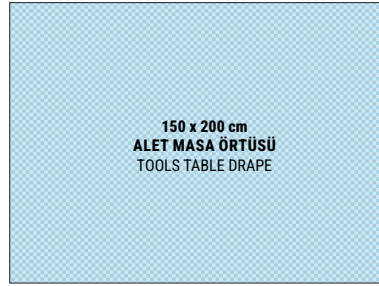

150 x 200 cm
ALET MASA ÖRTÜSÜ
TOOLS TABLE DRAPE

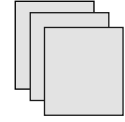

40 x 40 cm
HAVLU
TOWEL



78 x 145 cm
MAYO MASA ÖRTÜSÜ
MAYO TABLE DRAPE

REF: MED-STR031

Spinal Örtü Seti

Spinal Drape Set

İÇERİK / CONTENT	EBAT / SIZE	ADET / PIECES
Spinal Örtüsü Spinal Drape	200 x 300 cm	1
Alet Masa Örtüsü Tools Table Drape	150 x 200 cm	1
Mayo Masa Örtüsü Mayo Table Drape	78 x 145 cm	1
Yapışkan Bantlı Örtü Drape With Adhesive Tape	50 x 35 cm	2
Op-Tape Op-Tape	10 x 50 cm	2
Cilt Kalemi ve Cetveli Skin Marker And Ruler		1
Universal Torba Universal Bag	50 x 60 cm	1
Takviyeli Cerrahi Önlük Reinforced Surgical Gown	Large	3
Havlu Towel	40 x 40 cm	3
Sterilizasyon Bohçası Sterilization Wrap	100 x 100 cm	1



Oftalmoloji Örtü Setleri Ophthalmology Drape Sets

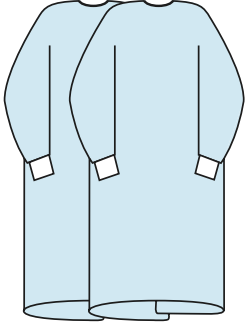

Large
STANDART CERRAHİ ÖNLÜK
STANDART SURGICAL GOWN

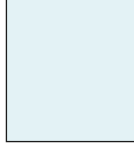

100 x 100 cm
STERİLİZASYON BOHÇASI
STERILIZATION WRAP

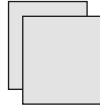

40 x 40 cm
HAVLU
TOWEL

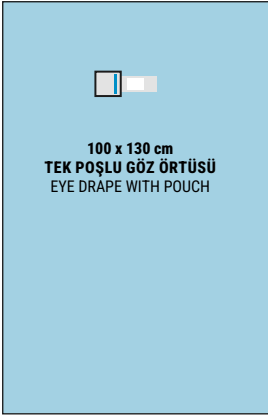

100 x 130 cm
TEK POŞLU GÖZ ÖRTÜSÜ
EYE DRAPE WITH POUCH

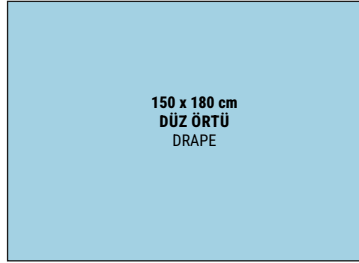

150 x 180 cm
DÜZ ÖRTÜ
DRAPE

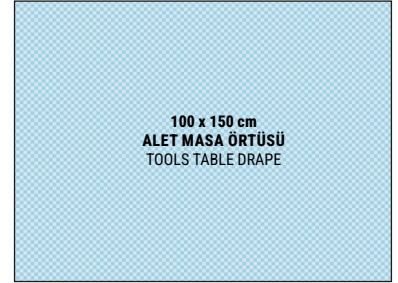

100 x 150 cm
ALET MASA ÖRTÜSÜ
TOOLS TABLE DRAPE

REF: MED-STR032

Göz Örtü Seti

Eye Drape Set

İÇERİK / CONTENT

EBAT / SIZE

ADET / PIECES

Tek Poşlu Göz Örtüsü
Eye Drape With Pouch

100 x 130 cm

1

Düz Örtü
Drape

150 x 180 cm

1

Alet Masa Örtüsü
Tools Table Drape

100 x 150 cm

1

Standart Cerrahi Önlük
Standard Surgical Gown

Large

2

Havlu
Towel

40 x 40 cm

2

Sterilizasyon Bohçası
Sterilization Wrap

100 x 100 cm

1

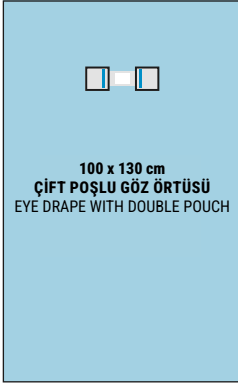

100 x 130 cm
ÇİFT POŞLU GÖZ ÖRTÜSÜ
EYE DRAPE WITH DOUBLE POUCH



100 x 150 cm
ÇİFT POŞLU GÖZ ÖRTÜSÜ
EYE DRAPE WITH DOUBLE POUCH

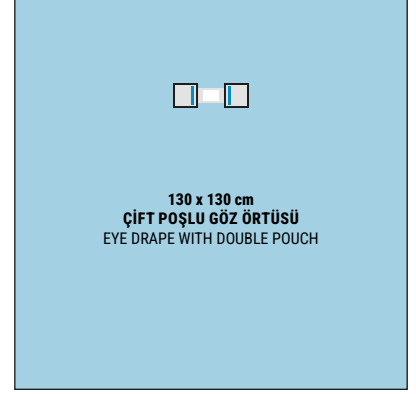

130 x 130 cm
ÇİFT POŞLU GÖZ ÖRTÜSÜ
EYE DRAPE WITH DOUBLE POUCH



150 x 150 cm
ÇİFT POŞLU GÖZ ÖRTÜSÜ
EYE DRAPE WITH DOUBLE POUCH

Çift Poşlu Göz Örtüleri

Eye Drapes With Double Pouch

İÇERİK / CONTENT

EBAT / SIZE

ADET / PIECES

Çift Poşlu Göz Örtüsü
Eye Drape With Double Pouch

100 x 130 cm

1

REF: MED-STR033

Çift Poşlu Göz Örtüsü
Eye Drape With Double Pouch

100 x 150 cm

1

REF: MED-STR034

Çift Poşlu Göz Örtüsü
Eye Drape With Double Pouch

130 x 130 cm

1

REF: MED-STR035

Çift Poşlu Göz Örtüsü
Eye Drape With Double Pouch

150 x 150 cm

1

REF: MED-STR036

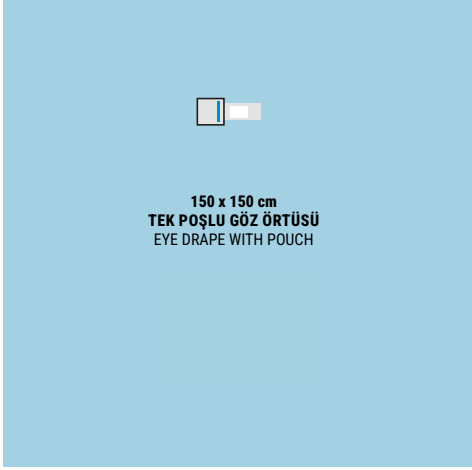
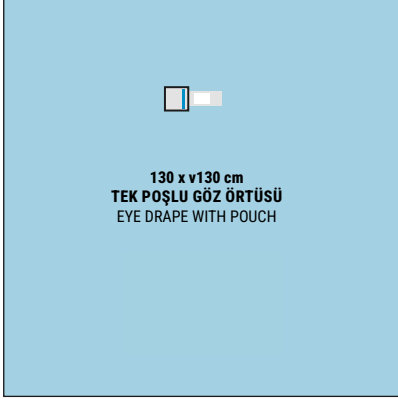

Tek Poşlu Göz Örtüleri

Eye Drapes With Pouch

İÇERİK / CONTENT

EBAT / SIZE

ADET / PIECES

Tek Poşlu Göz Örtüsü
Eye Drape With Pouch

100 x 130 cm

1

REF: MED-STR037

Tek Poşlu Göz Örtüsü
Eye Drape With Pouch

100 x 150 cm

1

REF: MED-STR038

Tek Poşlu Göz Örtüsü
Eye Drape With Pouch

130 x 130 cm

1

REF: MED-STR039

Tek Poşlu Göz Örtüsü
Eye Drape With Pouch

150 x 150 cm

1

REF: MED-STR040



Onkoloji Örtü Setleri Oncology Drape Sets

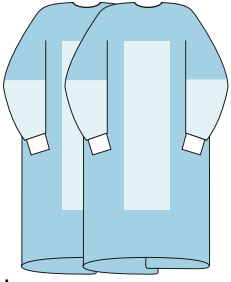

Large
TAKVİYELİ CERRAHİ ÖNLÜK
REINFORCED SURGICAL GOWN

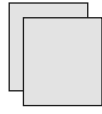

40 x 40 cm
HAVLU
TOWEL



40 x 120 cm
ÇALIŞMA ALTLIĞI
WORKING PAD

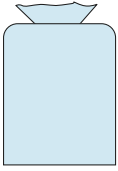

ATIK TORBASI
WASTE BAG

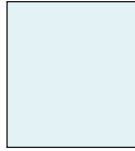

100 x 100 cm
STERİLİZASYON BOHÇASI
STERILIZATION WRAP



75 x 75 cm
KEMOTERAPİ ÖRTÜSÜ
CHEMOTHERAPY DRAPE

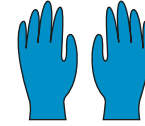

KEMOTERAPİ ELDİVENİ
CHEMOTHERAPY GLOVES



MASKE
MASK

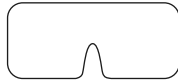

KORUYUCU GÖZLÜK
PROTECTIVE GLASSES

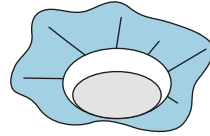

BONE
BONNET

REF: MED-STR041

Kemoterapi Örtü Seti Chemotherapy Drape Set

İÇERİK / CONTENT

EBAT / SIZE

ADET / PIECES

Kemoterapi Örtüsü
Chemotherapy Drape

75 x 75 cm

1

Çalışma Altlığı
Working Pad

40 x 120 cm

1

Maske
Mask

1

Koruyucu Gözlük
Protective Glasses

1

Bone
Bonnet

1

Kemoterapi Eldiveni
Chemotherapy Gloves

1 Çift / Pair

Atık Torbası
Waste Bag

1

Takviyeli Cerrahi Önlük
Reinforced Surgical Gown

Large

2

Havlu
Towel

40 x 40 cm

2

Sterilizasyon Bohçası
Sterilization Wrap

100 x 100 cm

1



Üroloji Örtü Setleri Urology Drape Sets

10 x 50 cm
OP-TAPE
OP-TAPE

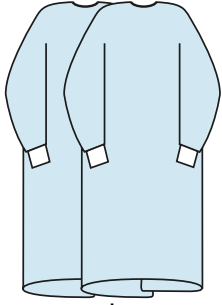

Large
STANDART CERRAHİ ÖNLÜK
STANDART SURGICAL GOWN



40 x 40 cm
HAVLU
TOWEL



80 x 80 cm
SKOPI KILIFI
SCOPY COVER



13 x 250 cm
KAMERA KILIFI
VIDEO CAMERA COVER

150 x 300 CM
PERTÜKAN ÖRTÜSÜ
PERCUTENEOUS DRAPE

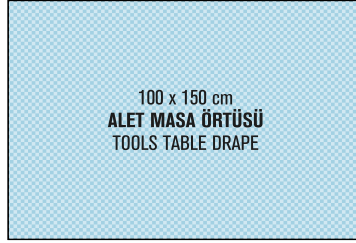
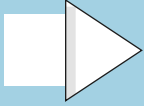

100 x 150 cm
ALET MASA ÖRTÜSÜ
TOOLS TABLE DRAPE

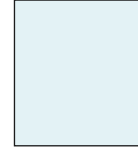

100 x 100 cm
STERİLİZASYON BOHÇASI
STERILIZATION WRAP

REF: MED-STRO42

Pertükan Örtü Seti

Percutaneous Drape Set

İÇERİK / CONTENT

EBAT / SIZE

ADET / PIECES

Perkütan Örtüsü
Percutaneous Drape Set

150 x 300 cm

1

Alet Masa Örtüsü
Tools Table Drape

100 x 150 cm

1

Op-Tape
Op-Tape

10 x 50 cm

2

Skopi Kılıfı
Scopy Cover

80 x 80 cm

1

Kamera Kılıfı
Video Camera Cover

13 x 250 cm

1

Takviyeli Cerrahi Önlük
Reinforced Surgical Gown

Large

2

Havlu
Towel

40 x 40 cm

2

Sterilizasyon Bohçası
Sterilization Wrap

100 x 100 cm

1

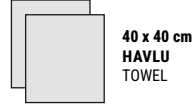

40 x 40 cm
HAVLU
TOWEL

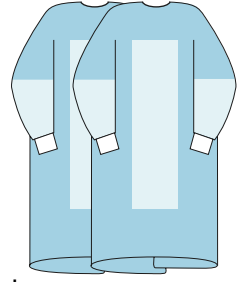

Large
TAKVİYELİ CERRAHİ ÖNLÜK
REINFORCED SURGICAL GOWN



100 x 100 cm
STERİLİZASYON BOHÇASI
STERILIZATION WRAP



13 x 250 cm
KAMERA KILIFI
VIDEO CAMERA COVER

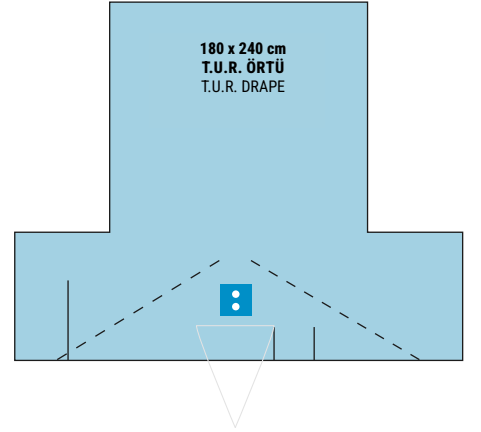

180 x 240 cm
T.U.R. ÖRTÜ
T.U.R. DRAPE

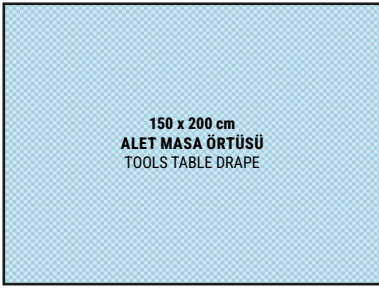

150 x 200 cm
ALET MASA ÖRTÜSÜ
TOOLS TABLE DRAPE

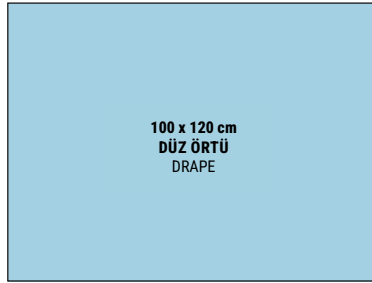

100 x 120 cm
DÜZ ÖRTÜ
DRAPE

REF: MED-STRO43

T.U.R. Örtü Seti

T.U.R. Drape Set

İÇERİK / CONTENT

EBAT / SIZE

ADET / PIECES

T.U.R. Örtüsü
T.U.R. Drape

180 x 240 cm

1

Düz Örtü
Drape

100 x 120 cm

1

Alet Masa Örtüsü
Tools Table Drape

150 x 200 cm

1

Takviyeli Cerrahi Önlük
Reinforced Surgical Gown

Large

2

Kamera Kılıfı
Video Camera Cover

13 x 250 cm

1

Havlu
Towel

40 x 40 cm

2

Sterilizasyon Bohçası
Sterilization Wrap

100 x 100 cm

1

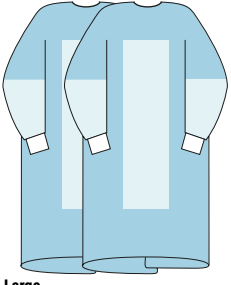

Large
TAKVİYELİ CERRAHİ ÖNLÜK
REINFORCED SURGICAL GOWN



100 x 100 cm
STERİLİZASYON BOHÇASI
STERILIZATION WRAP

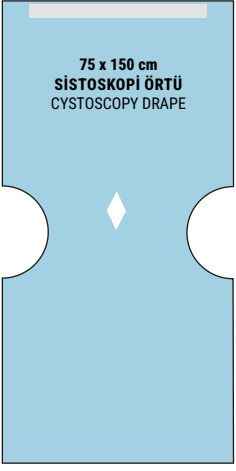

75 x 150 cm
SİSTOSKOPİ ÖRTÜ
CYSTOSCOPY DRAPE



60 x 120 cm
BACAK KILIFI
LEG COVER

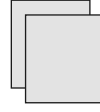

40 x 40 cm
HAVLU
TOWEL



150 x 200 cm
ALET MASA ÖRTÜSÜ
TOOLS TABLE DRAPE



100 x 120 cm
DÜZ ÖRTÜ
DRAPE

REF: MED-STRO44

Sistoskopi Örtü Seti

Cystoscopy Drape Set

İÇERİK / CONTENT

EBAT / SIZE

ADET / PIECES

Sistoskopi Örtüsü
Cystoscopy Drape

75 x 150 cm

1

Düz Örtü
Drape

100 x 120 cm

1

Alet Masa Örtüsü
Tools Table Drape

150 x 200 cm

1

Bacak Kılıfı
Leg Cover

60 x 120 cm

2

Takviyeli Cerrahi Önlük
Reinforced Surgical Gown

Large

2

Havlu
Towel

40 x 40 cm

2

Sterilizasyon Bohçası
Sterilization Wrap

100 x 100 cm

1



Radyoloji Örtü Setleri Radiology Drape Sets

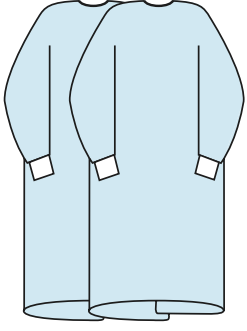

Large
STANDART CERRAHİ ÖNLÜK
STANDART SURGICAL GOWN

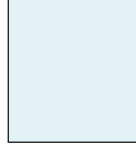

75 x 75 cm
STERİLİZASYON BOHÇASI
STERILIZATION WRAP

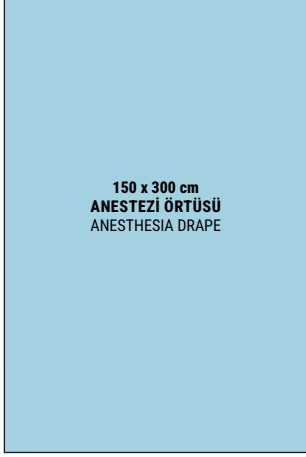

150 x 300 cm
ANESTEZİ ÖRTÜSÜ
ANESTHESIA DRAPE



100 x 150 cm
ALET MASA ÖRTÜSÜ
TOOLS TABLE DRAPE

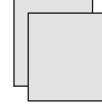

40 x 40 cm
HAVLU
TOWEL

REF: MED-STRO45

Biopsi (Tese) Örtü Seti

Biopsy (Tese) Drape Set

İÇERİK / CONTENT

EBAT / SIZE

ADET / PIECES

Anestezi Örtüsü
Anesthesia Drape

150 x 300 cm

1

Alet Masa Örtüsü
Tools Table Drape

100 x 150 cm

1

Standart Cerrahi Önlük
Standard Surgical Gown

Large

2

Havlu
Towel

40 x 40 cm

2

Sterilizasyon Bohçası
Sterilization Wrap

75 x 75 cm

1



K.B.B. Cerrahi Örtü Setleri E.N.T. Drape Sets

10 x 30 cm
OP-TAPE
OP-TAPE

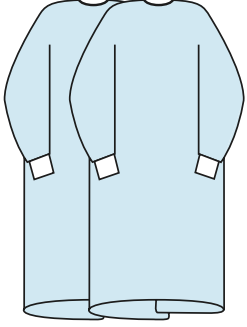

Large
STANDART CERRAHİ ÖNLÜK
STANDART SURGICAL GOWN

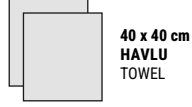

40 x 40 cm
HAVLU
TOWEL

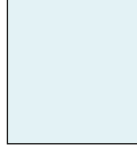

100 x 100 cm
STERİLİZASYON BOHÇASI
STERILIZATION WRAP

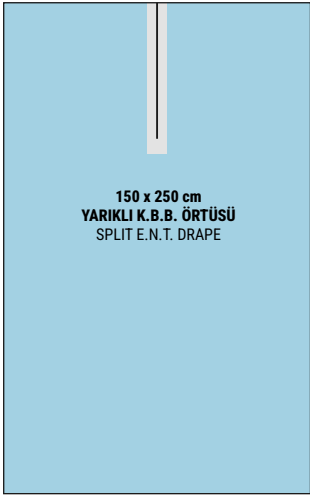

150 x 250 cm
YARIKLI K.B.B. ÖRTÜSÜ
SPLIT E.N.T. DRAPE

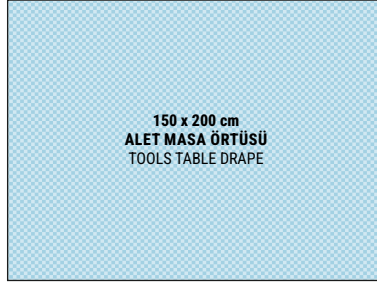

150 x 200 cm
ALET MASA ÖRTÜSÜ
TOOLS TABLE DRAPE



100 x 120 cm
DÜZ ÖRTÜ
DRAPE

REF: MED-STRO46

K.B.B. Örtü Seti

E.N.T. Drape Set

İÇERİK / CONTENT

EBAT / SIZE

ADET / PIECES

Yarıklı K.B.B. Örtüsü
Split E.N.T. Drape

150 x 250 cm

1

Alet Masa Örtüsü
Tools Table Drape

150 x 200 cm

1

Düz Örtü
Drape

100 x 120 cm

1

Op-Tape
Op-Tape

10 x 30 cm

2

Standart Cerrahi Önlük
Standard Surgical Gown

Large

2

Havlu
Towel

40 x 40 cm

2

Sterilizasyon Bohçası
Sterilization Wrap

100 x 100 cm

1



10 x 30 cm
OP-TAPE
OP-TAPE

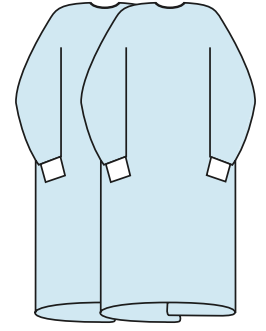

Large
STANDART CERRAHİ ÖNLÜK
STANDART SURGICAL GOWN

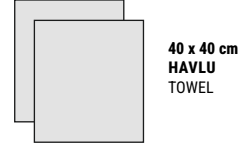

40 x 40 cm
HAVLU
TOWEL

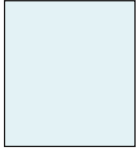

100 x 100 cm
STERİLİZASYON BOHÇASI
STERILIZATION WRAP



150 x 200 cm
ALET MASA ÖRTÜSÜ
TOOLS TABLE DRAPE

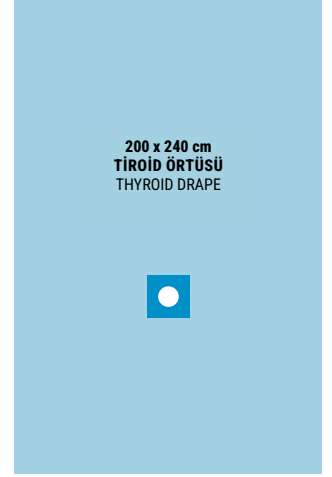

200 x 240 cm
TİROİD ÖRTÜSÜ
THYROID DRAPE

REF: MED-STRO47

Tiroid Örtü Seti

Thyroid Drape Set

İÇERİK / CONTENT

EBAT / SIZE

ADET / PIECES

Tiroid Örtüsü
Thyroid Drape

200 x 240 cm

1

Alet Masa Örtüsü
Tools Table Drape

150 x 200 cm

1

Op-Tape
Op-Tape

10 x 30 cm

2

Standart Cerrahi Önlük
Standard Surgical Gown

Large

2

Havlu
Towel

40 x 40 cm

2

Sterilizasyon Bohçası
Sterilization Wrap

100 x 100 cm

1



Estetik Cerrahi Örtü Setleri

Aesthetic Drape Sets



40 x 40 cm
HAVLU
TOWEL

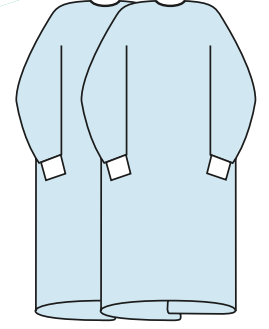

Large
STANDART CERRAHI ÖNLÜK
STANDART SURGICAL GOWN



78 x 145 cm
MAYO MASA ÖRTÜSÜ
MAYO TABLE DRAPE

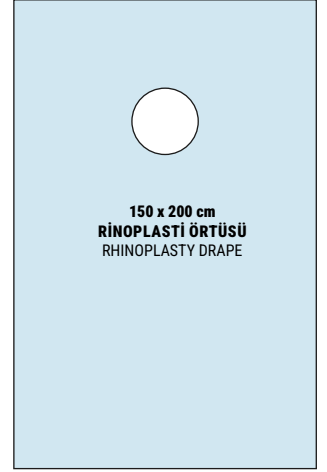

150 x 200 cm
RİNOPLASTİ ÖRTÜSÜ
RHINOPLASTY DRAPE

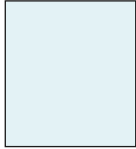

75 x 75 cm
STERİLİZASYON BOHÇASI
STERILIZATION WRAP

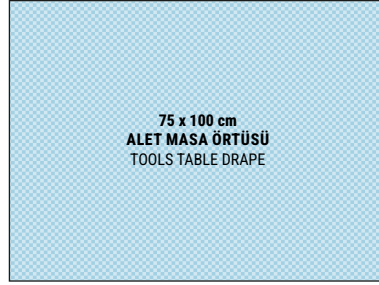

75 x 100 cm
ALET MASA ÖRTÜSÜ
TOOLS TABLE DRAPE

REF: MED-STRO48

Rinoplasti Örtü Seti

Rhinoplasty Drape Set

İÇERİK / CONTENT

EBAT / SIZE

ADET / PIECES

Rinoplasti Örtüsü
Rhinoplasty Drape

150 x 200 cm

1

Alet Masa Örtüsü
Tools Table Drape

75 x 100 cm

1

Mayo Masa Örtüsü
Mayo Table Drape

78 x 145 cm

1

Standart Cerrahi Önlük
Standard Surgical Gown

Large

2

Havlu
Towel

40 x 40 cm

2

Sterilizasyon Bohçası
Sterilization Wrap

75 x 75 cm

1

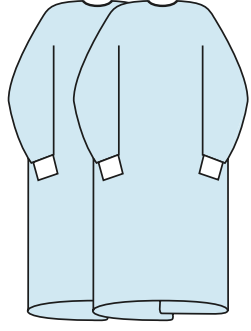

Large
STANDART CERRAHİ ÖNLÜK
STANDART SURGICAL GOWN

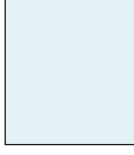

100 x 100 cm
STERİLİZASYON BOHÇASI
STERILIZATION WRAP

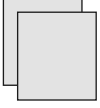

40 x 40 cm
HAVLU
TOWEL



60 x 120 cm
BACAK KILIFI
LEG COVER



78 x 145 cm
MAYO MASA ÖRTÜSÜ
MAYO TABLE DRAPE

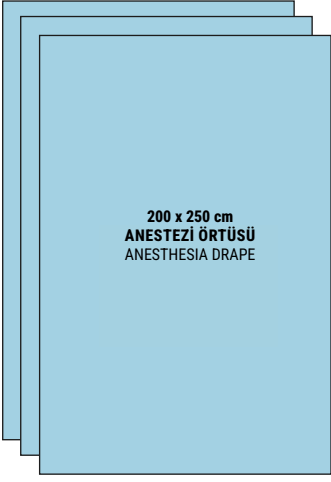

200 x 250 cm
ANESTEZİ ÖRTÜSÜ
ANESTHESIA DRAPE

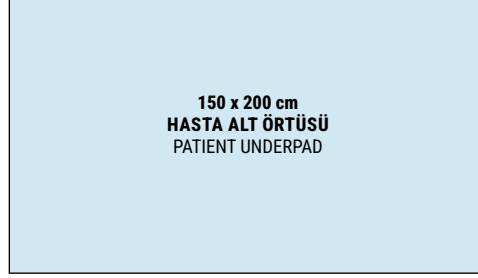

150 x 200 cm
HASTA ALT ÖRTÜSÜ
PATIENT UNDERPAD



100 x 150 cm
ALET MASA ÖRTÜSÜ
TOOLS TABLE DRAPE

REF: MED-STRO49

Liposculptre Örtü Seti

Liposculptre Drape Set

İÇERİK / CONTENT

EBAT / SIZE

ADET / PIECES

Anestezi Örtüsü
Anesthesia Drape

200 x 250 cm

3

Hasta Alt Örtüsü
Patient Underpad

150 x 200 cm

1

Bacak Kılıfı
Leg Cover

60 x 120 cm

2

Alet Masa Örtüsü
Tools Table Drape

100 x 150 cm

1

Mayo Masa Örtüsü
Mayo Table Drape

78 x 145 cm

1

Standart Cerrahi Önlük
Standard Surgical Gown

Large

2

Havlu
Towel

40 x 40 cm

2

Sterilizasyon Bohçası
Sterilization Wrap

100 x 100 cm

1

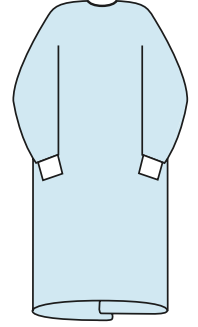

Large
STANDART CERRAHİ ÖNLÜK
STANDART SURGICAL GOWN

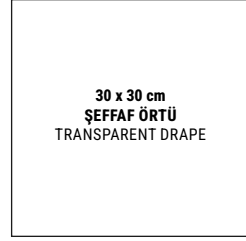

30 x 30 cm
ŞEFFAF ÖRTÜ
TRANSPARENT DRAPE

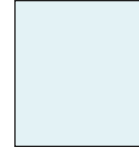

75 x 75 cm
STERİLİZASYON BOHÇASI
STERILIZATION WRAP

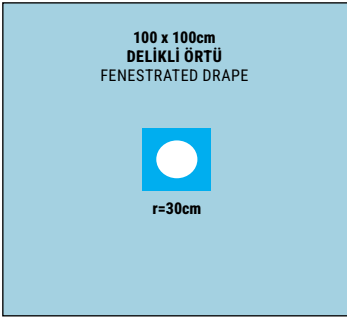

100 x 100cm
DELİKLİ ÖRTÜ
FENESTRATED DRAPE



r=30cm

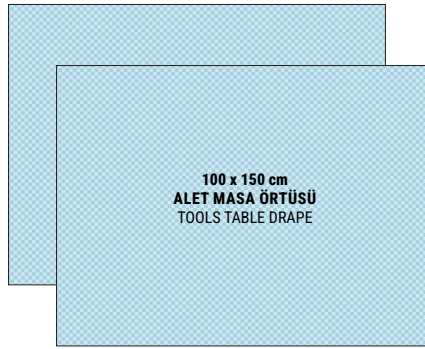

100 x 150 cm
ALET MASA ÖRTÜSÜ
TOOLS TABLE DRAPE

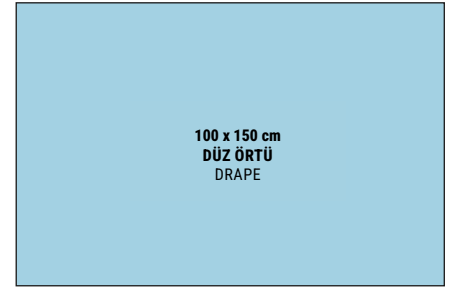

100 x 150 cm
DÜZ ÖRTÜ
DRAPE

REF: MED-STRO50

Saç Ekim Örtü Seti

Hair Transplantation Drape Set

İÇERİK / CONTENT

EBAT / SIZE

ADET / PIECES

Delikli Örtü
Fenestrated Drape

100 x 100 cm

1

Düz Örtü
Drape

100 x 150 cm

1

Şeffaf Örtü
Transparent Drape

30 x 30 cm

1

Standart Cerrahi Önlük
Standard Surgical Gown

Large

1

Alet Masa Örtüsü
Tools Table Drape

100 x 150 cm

2

Sterilizasyon Bohçası
Sterilization Wrap

75 x 75 cm

1



Diş Cerrahi Örtü Setleri Dental Drape Sets

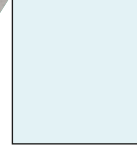

100 x 100 cm
STERİLİZASYON BOHÇASI
STERILIZATION WRAP

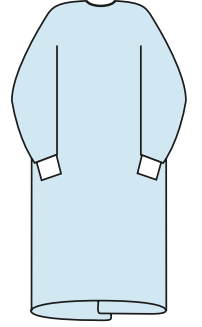

Large
STANDART CERRAHİ ÖNLÜK
STANDART SURGICAL GOWN

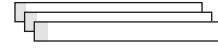

8 x 200 cm
ŞEFFAF HORTUM KILIFI
TRANSPARENT HOSE COVER

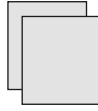

40 x 40 cm
HAVLU
TOWEL



100 x 150 cm
ALET MASA ÖRTÜSÜ
TOOLS TABLE DRAPE



150 x 150cm
YAPIŞKAN BANTLI ÖRTÜ
DRAPE WITH ADHESIVE TAPE

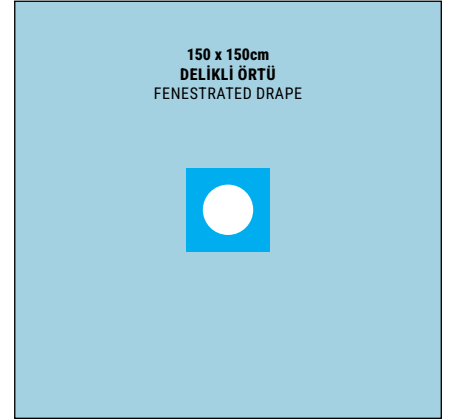

150 x 150cm
DELİKLİ ÖRTÜ
FENESTRATED DRAPE

REF: MED-STR051

Diş Örtü Seti Dental Drape Set

İÇERİK / CONTENT

EBAT / SIZE

ADET / PIECES

Delikli Örtü
Fenestrated Drape

150 x 150 cm

1

Yapışkan Bantlı Örtüsü
Drape With Adhesive Tape

150 x 150 cm

1

Alet Masa Örtüsü
Tools Table Drape

100 x 150 cm

1

Şeffaf Hortum Kılıfı
Transparent Hose Cover

8 x 200 cm

3

Standart Cerrahi Önlük
Standard Surgical Gown

Large

1

Havlu
Towel

40 x 40 cm

2

Sterilizasyon Bohçası
Sterilization Wrap

100 x 100 cm

1

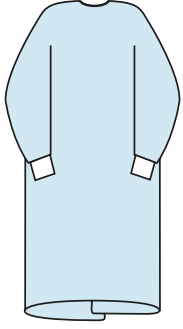

Large
STANDART CERRAHİ ÖNLÜK
STANDART SURGICAL GOWN



40 x 40 cm
HAVLU
TOWEL

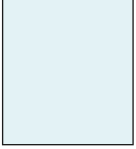

75 x 75 cm
STERİLİZASYON BOHÇASI
STERILIZATION WRAP



7,5 x 7,5 cm
SPANÇ
GAUZE SWAB

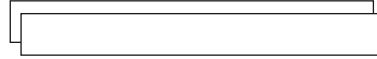

10 x 200 cm
ŞEFFAF ÖRTÜ
TRANSPARENT DRAPE

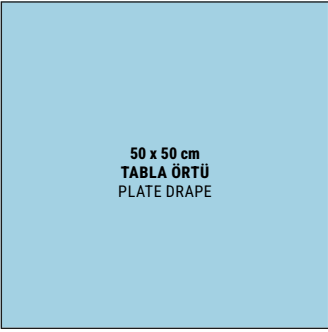

50 x 50 cm
TABLA ÖRTÜ
PLATE DRAPE



75 x 75 cm
ALET MASA ÖRTÜSÜ
TOOLS TABLE DRAPE

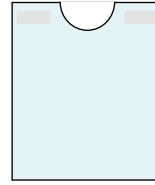

70 x 85 cm
BANTLI HASTA ÖNLÜĞÜ
PATIENT GOWN WITH TAPE

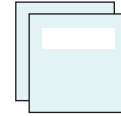

15 x 15 cm
REFLEKTÖR ÖRTÜSÜ
REFLECTOR DRAPE

REF: MED-STR052

Implant Örtü Seti Implant Drape Set

İÇERİK / CONTENT

EBAT / SIZE

ADET / PIECES

Tabla Örtüsü
Plate Drape

50 x 50 cm

1

Alet Masa Örtüsü
Tools Table Drape

75 x 75 cm

1

Bantlı Hasta Önlüğü
Patient Gown With Tape

75 x 85 cm

1

Spanç
Gauze Swab

7,5 x 7,5 cm

10

Şeffaf Örtü
Transparent Drape

10 x 200 cm

2

Reflektör Örtüsü
Reflector Drape

15 x 15 cm

2

Standart Cerrahi Önlük
Standard Surgical Gown

Large

1

Havlu
Towel

40 x 40 cm

1

Sterilizasyon Bohçası
Sterilization Wrap

75 x 75 cm

1

Cerrahi Önlükler

Surgical Gowns

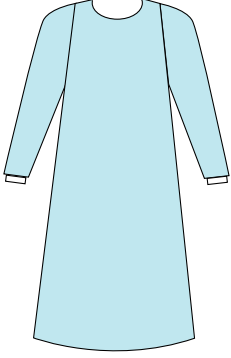

STANDART CERRAHİ ÖNLÜK
STANDARD SURGICAL GOWN

REF: MED-STR060



TAKVİYELİ CERRAHİ ÖNLÜK
REINFORCED SURGICAL GOWN

REF: MED-STR061

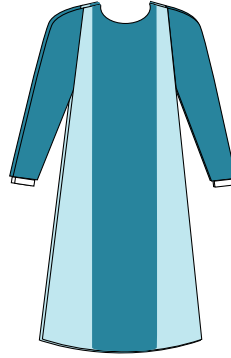

TAM TAKVİYELİ CERRAHİ ÖNLÜK
FULL REINFORCED SURGICAL GOWN

REF: MED-STR062

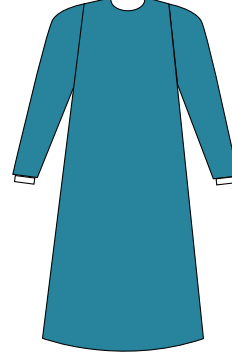

KEMOTERAPİ ÖNLÜĞÜ
CHEMOTHERAPY GOWN

REF: MED-STR063

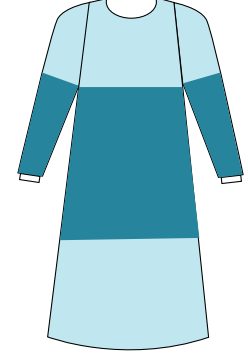

ÇOK KULLANIMLIK CERRAHİ BOX ÖNLÜK
RESUABLE SURGICAL BOX GOWN

REF: MED-NSN08

Önlük Setleri

Gown Sets

STANDART CERRAHİ ÖNLÜK SETİ-1

STANDARD SURGICAL GOWN SET -1

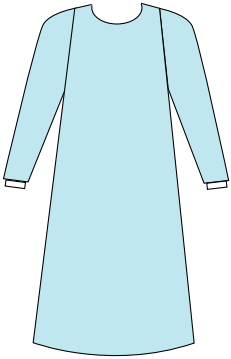

İÇERİK / CONTENT

Standart Cerrahi Önlük
Standard Surgical Gown

EBAT / SIZE

SMS 40GSM

ADET / PIECES

1

Havlu
Towel

40 x 40 cm

1

Sterilizasyon Bohçası
Sterilization Wrap

40 x 40 cm

1

BEDEN

ÖLÇÜ

Small	145 (G) cm x 110 (U) cm
Medium	150 (G) cm x 115 (U) cm
Large	155 (G) cm x 120 (U) cm
X-Large	160 (G) cm x 130 (U) cm
XX-Large	160 (G) cm x 135 (U) cm
XXX-Large	170 (G) cm x 140 (U) cm

REF: MED-STR064

STANDART CERRAHİ ÖNLÜK SETİ-2

STANDARD SURGICAL GOWN SET-2

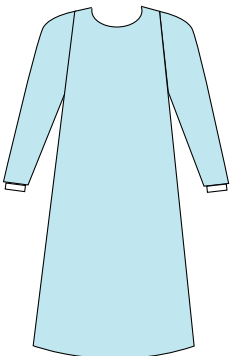

İÇERİK / CONTENT

Standart Cerrahi Önlük
Standard Surgical Gown

EBAT / SIZE

SMS 40GSM

ADET / PIECES

1

Havlu
Towel

40 x 40 cm

2

Sterilizasyon Bohçası
Sterilization Wrap

40 x 40 cm

1

BEDEN

ÖLÇÜ

Small	145 (G) cm x 110 (U) cm
Medium	150 (G) cm x 115 (U) cm
Large	155 (G) cm x 120 (U) cm
X-Large	160 (G) cm x 130 (U) cm
XX-Large	160 (G) cm x 135 (U) cm
XXX-Large	170 (G) cm x 140 (U) cm

REF: MED-STR065

TAKVİYELİ CERRAHİ ÖNLÜK SETİ-1 REINFORCED SURGICAL GOWN SET-1



İÇERİK / CONTENT

EBAT / SIZE

ADET / PIECES

Takviyeli Cerrahi Önlük
Reinforced Surgical Gown

Triplex
56GSM

1

Havlu
Towel

40 x 40 cm

1

Sterilizasyon Bohçası
Sterilization Wrap

40 x 40 cm

1

BEDEN

ÖLÇÜ

Small	145 (G) cm x 110 (U) cm
Medium	150 (G) cm x 115 (U) cm
Large	155 (G) cm x 120 (U) cm
X-Large	160 (G) cm x 130 (U) cm
XX-Large	160 (G) cm x 135 (U) cm
XXX-Large	170 (G) cm x 140 (U) cm

REF: MED-STR066

TAKVİYELİ CERRAHİ ÖNLÜK SETİ-2 REINFORCED SURGICAL GOWN SET-



İÇERİK / CONTENT

EBAT / SIZE

ADET / PIECES

Takviyeli Cerrahi Önlük
Reinforced Surgical Gown

Triplex
56GSM

1

Havlu
Towel

40 x 40 cm

2

Sterilizasyon Bohçası
Sterilization Wrap

40 x 40 cm

1

BEDEN

ÖLÇÜ

Small	145 (G) cm x 110 (U) cm
Medium	150 (G) cm x 115 (U) cm
Large	155 (G) cm x 120 (U) cm
X-Large	160 (G) cm x 130 (U) cm
XX-Large	160 (G) cm x 135 (U) cm
XXX-Large	170 (G) cm x 140 (U) cm

REF: MED-STR067

TAM TAKVİYELİ CERRAHİ ÖNLÜK SETİ-1 FULL REINFORCED SURGICAL GOWN SET-1



İÇERİK / CONTENT

EBAT / SIZE

ADET / PIECES

Tam Takviyeli Cerrahi Önlük
Full Reinforced Surgical Gown

Triplex
56GSM

1

Havlu
Towel

40 x 40 cm

1

Sterilizasyon Bohçası
Sterilization Wrap

40 x 40 cm

1

BEDEN

ÖLÇÜ

Small	145 (G) cm x 110 (U) cm
Medium	150 (G) cm x 115 (U) cm
Large	155 (G) cm x 120 (U) cm
X-Large	160 (G) cm x 130 (U) cm
XX-Large	160 (G) cm x 135 (U) cm
XXX-Large	170 (G) cm x 140 (U) cm

REF: MED-STR068

TAM TAKVİYELİ CERRAHİ ÖNLÜK SETİ-2 FULL REINFORCED SURGICAL GOWN SET-2

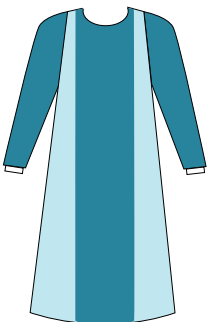

İÇERİK / CONTENT

EBAT / SIZE

ADET / PIECES

Standart Cerrahi Önlük
Standard Surgical Gown

Triplex
56GSM

1

Havlu
Towel

40 x 40 cm

2

Sterilizasyon Bohçası
Sterilization Wrap

40 x 40 cm

1

BEDEN

ÖLÇÜ

Small	145 (G) cm x 110 (U) cm
Medium	150 (G) cm x 115 (U) cm
Large	155 (G) cm x 120 (U) cm
X-Large	160 (G) cm x 130 (U) cm
XX-Large	160 (G) cm x 135 (U) cm
XXX-Large	170 (G) cm x 140 (U) cm

REF: MED-STR069

Diğer Tek Kullanımlık Ürünler

Other Disposable Products

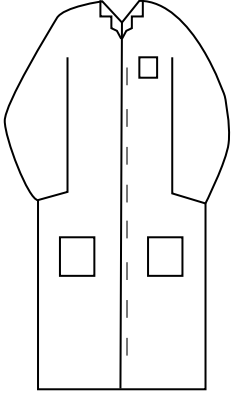

ZİYARETÇİ ÖNLÜĞÜ
VISITOR GOWN
REF:MED-NSN100

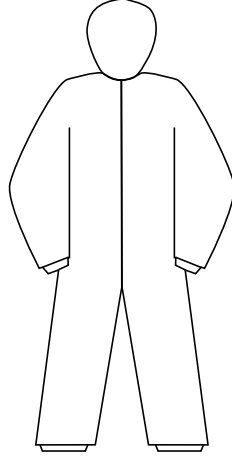

TULUM
COVERALL
REF:MED-NSN101

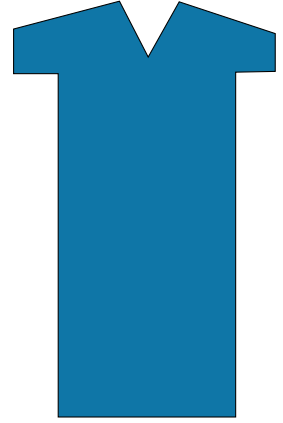

KISA KOLLU HASTA MUAYENE
SHORT SLEEVE PATIENT EXAMINATION
REF:MED-NSN09

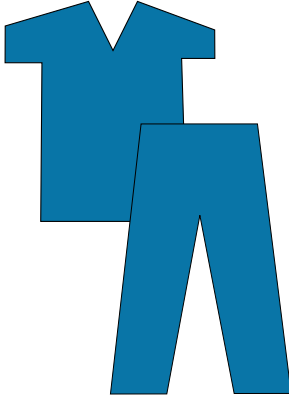

ALT ÜST TAKIM
TSHIRT AND PANTH
REF:MED-NSN03

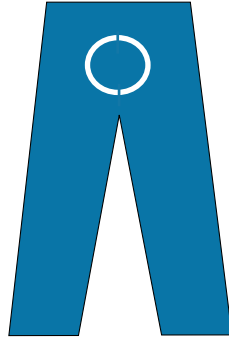

KOLONOSKOPİ PANTOLON
COLONOSCOPY PANTH
REF:MED-NSN01

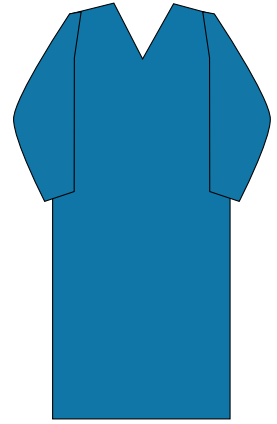

UZUN KOLLU HASTA MUAYENE
LONG SLEEVE PATIENT EXAMINATION
REF:MED-NSN10

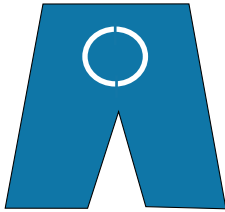

KOLONOSKOPİ ŞORT
COLONOSCOPY SHORT
REF:MED-NSN01

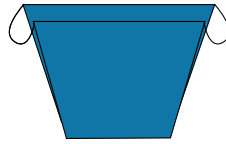

ANJİYO ŞORT
ANGIO SHORT
REF:MED-NSN02

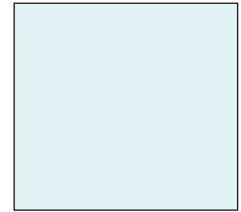

STERİLİZASYON BOHÇASI
STERILIZATION WRAP
REF:MED-WRP

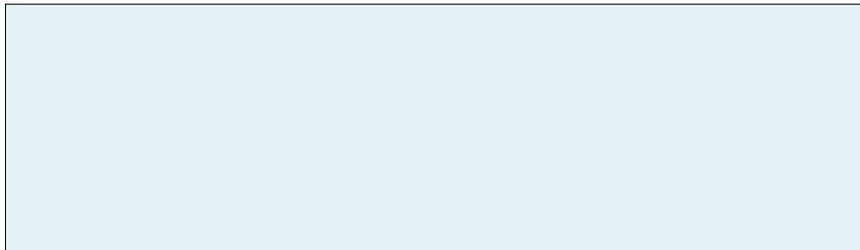

SEDYE ÖRTÜSÜ
STROTCHER
REF: MED-NSN04



CERRAHİ BAĞCIKLI MASKE
FACE SURGICAL MASK



CERRAHİ MASKE
SURGICAL MASK



Web Site Ziyareti İçin
For Web Site Visit

"30 Yılı Aşkın Tecrübe, Yenilikçi Çözümler"



MEDİCENZ PHARMA ECZA DEPOSU SAN. VE TİC. LTD ŞTİ.

Yeni Bağlıca Mah. Zirve Cad. No:80 Etimesgut / Ankara

+90 312 219 60 14 +90 312 234 54 54 www.medicenz.com info@medicenz.com

